



# **$\frac{1}{4}$ -DIN, $\frac{1}{8}$ -DIN & $\frac{1}{16}$ -DIN TEMPERATURE CONTROLLERS**

## **Product Manual**

# PREFACE

This manual comprises two volumes:

Volume 1: This supports normal operation of the  $\frac{1}{4}$ -DIN,  $\frac{1}{8}$ -DIN and  $\frac{1}{16}$ -DIN Temperature Controllers. In normal operation, all actions taken by the user are to be in front of the panel.

Volume 2: This supports the installation, commissioning and configuring of the  $\frac{1}{4}$ -DIN,  $\frac{1}{8}$ -DIN and  $\frac{1}{16}$ -DIN Temperature Controllers. *It is intended for use only by personnel who are trained, equipped and authorised to carry out these functions.*

# **$\frac{1}{4}$ -DIN, $\frac{1}{8}$ -DIN & $\frac{1}{16}$ -DIN TEMPERATURE CONTROLLERS**

## **PRODUCT MANUAL**

### **VOLUME 1 OPERATING INSTRUCTIONS**

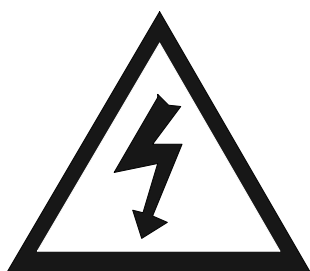

In normal operation, the operator must not remove the Controller from its housing or have unrestricted access to the rear terminals, as this would provide potential contact with hazardous live parts.

Installation and configuration must be undertaken by technically-competent servicing personnel. This is covered in Volume 2 of this manual.

### **Contents - Volume 1**

<b>1</b>	<b>OPERATOR MODE</b>	<b>1-1</b>
1.1	INTRODUCTION	1-1
1.2	DISPLAYS AVAILABLE	1-2
1.3	ADJUSTING THE SETPOINT/SETPOINT RAMP RATE	1-3
1.4	ALARM STATUS DISPLAY	1-3
1.5	OVER-RANGE/UNDER-RANGE DISPLAYS	1-4
1.6	SENSOR BREAK INDICATION	1-4
1.7	MANUAL CONTROL MODE	1-4
1.8	PRE-TUNE FACILITY	1-5
1.9	SELF-TUNE FACILITY	1-6
1.10	VIEWING THE HARDWARE DEFINITION CODE	1-7

<b>2</b>	<b>SET UP MODE</b>	<b>2-1</b>
2.1	ENTRY INTO SET UP MODE	2-1
2.2	SET UP MODE PARAMETERS	2-2
2.3	OPERATOR MODE DISPLAYS	2-13
2.4	TUNING THE CONTROLLER MANUALLY	2-13
2.5	SELF-TUNE AND PRE-TUNE FACILITIES	2-14
2.6	EXIT FROM SET UP MODE	2-15
<b>3</b>	<b>RS485 SERIAL COMMUNICATIONS</b>	<b>3-1</b>
3.1	COMMUNICATIONS ENABLE/DISABLE	3-1
3.2	PHYSICAL REQUIREMENTS	3-1
3.3	INDIVIDUAL PARAMETERS	3-5
3.4	ERROR RESPONSE	3-10

# 1 OPERATOR MODE

## 1.1 INTRODUCTION

This Section covers the routine operation of the Controller, once it has been installed and configured as described in Volume 2 of this manual. The Controller front panel indicators and keys are shown in Figure 1-1.

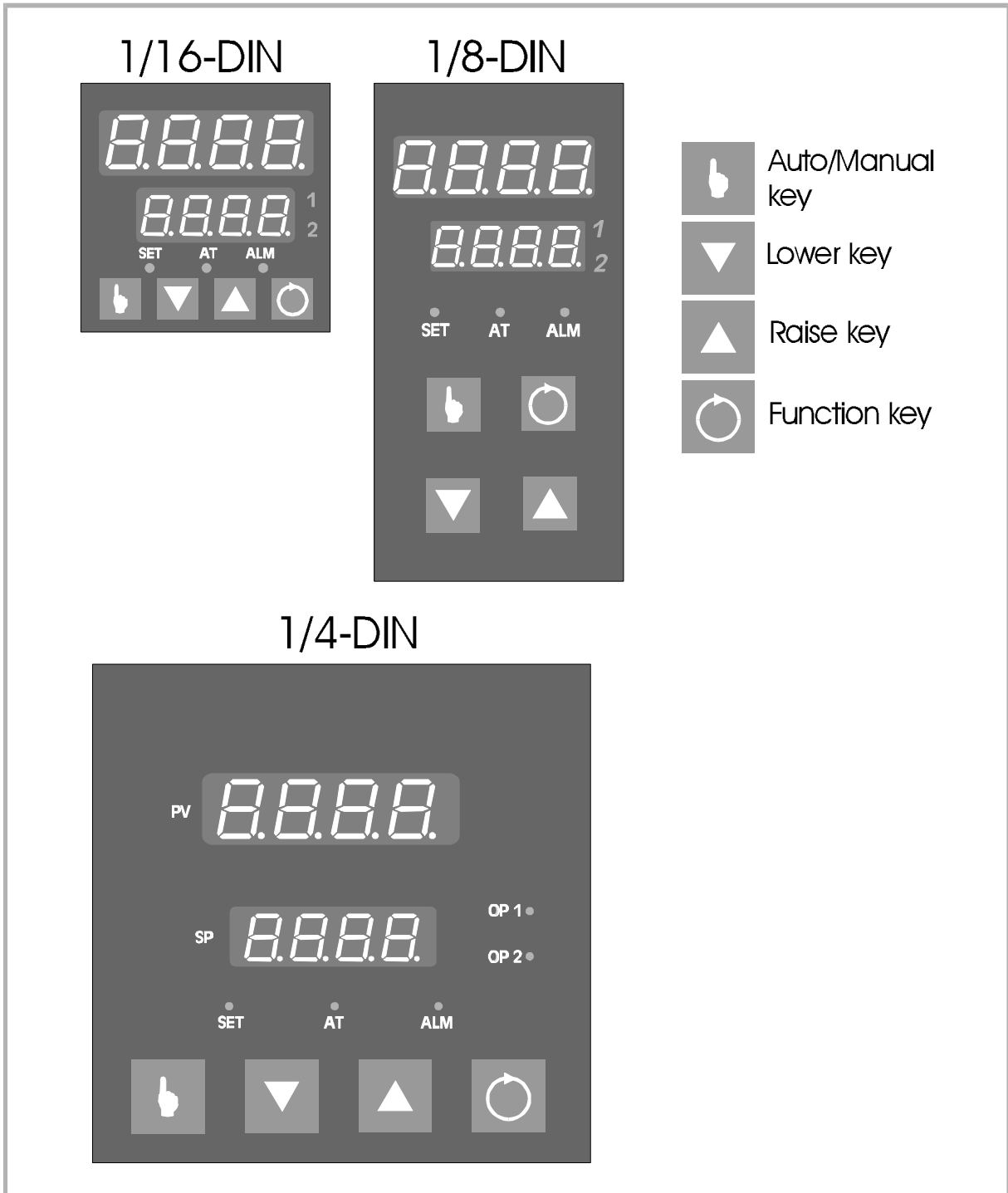

Figure 1-1 Front Panel Controls and Indicators

## 1.2 DISPLAYS AVAILABLE

After the Controller has performed its power-up self-test (during which, if the Function key is held down during power-up, the current Controller firmware revision is displayed), the initial displays appear. The available displays are dependent upon (a) whether the Controller has been configured for Single Setpoint operation or Dual Setpoint operation and (b) the setting of the Setpoint Strategy parameter in Set Up Mode.

### 1.2.1 Single Setpoint Operation:

In single setpoint operation, the available displays are:

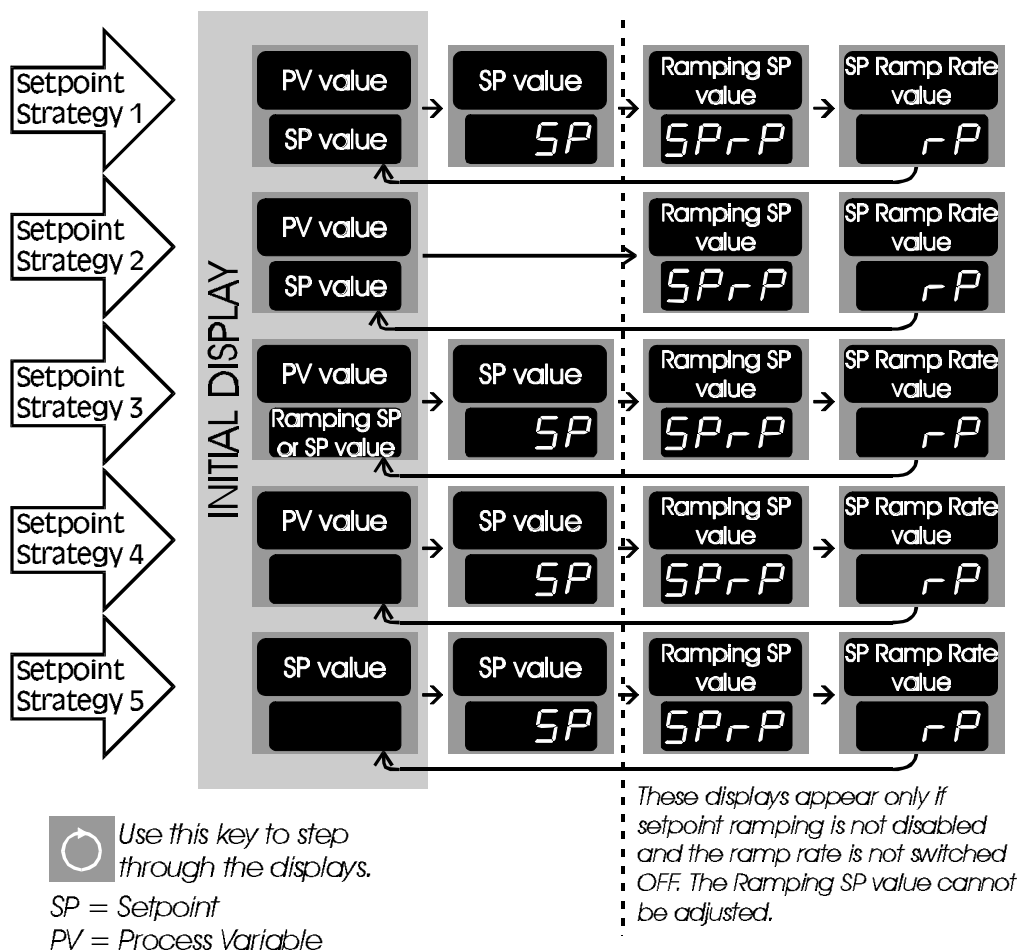

### 1.2.2 Dual Setpoint Operation

In dual setpoint operation, the available displays are:

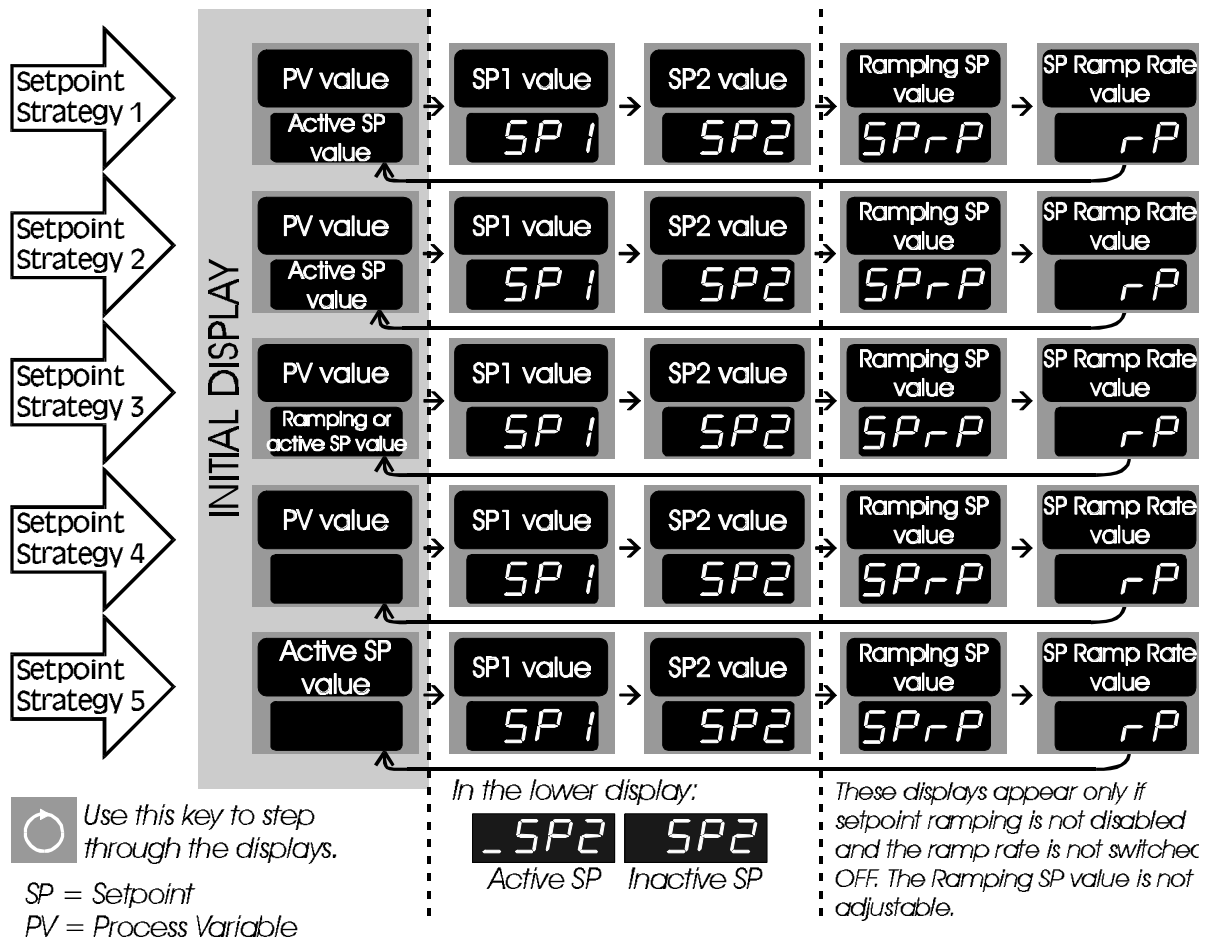

### 1.3 ADJUSTING THE SETPOINT/SETPOINT RAMP RATE

The setpoint/setpoint ramp rate (whichever is selected - see previously) may be adjusted using the Raise/Lower keys. The ramp rate may be adjusted in the range 1 to 9999. Any attempt to increase the ramp rate value beyond 9999 will cause the upper display to go blank and setpoint ramping to be switched OFF. Setpoint ramping can be resumed by decreasing the ramp rate value to 9999 or less.

### 1.4 ALARM STATUS DISPLAY

If one or more of the Controller's alarms is (are) active, the alarm status display is included in the available display sequence. The Alarm Status display is selected by depressing the Function key repeatedly until the display appears (see Figure 1-2).

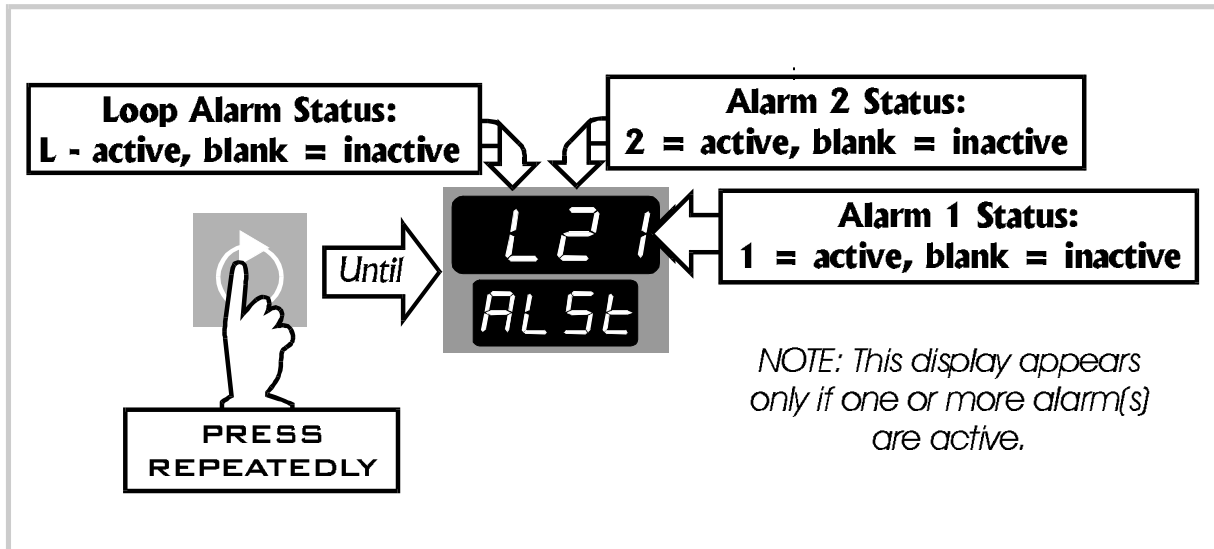
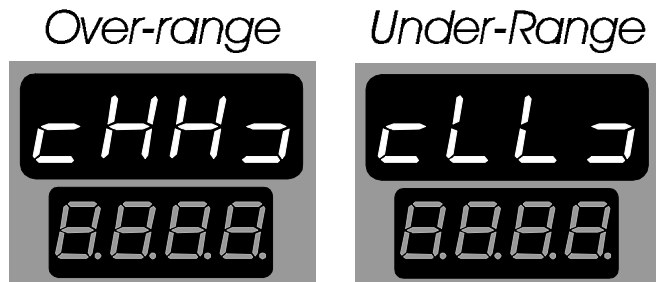

Figure 1-2 Alarm Status Display

## 1.5 OVER-RANGE/UNDER-RANGE DISPLAYS

The upper display will indicate if the process variable is higher than the input scale maximum limit (over-range), or lower than the input scale minimum limit (under-range) as shown on the right.



## 1.6 SENSOR BREAK INDICATION

If a break is detected in the sensor circuit, the upper display shows:

OPEN

The reaction of the outputs and alarms to a detected sensor break is dependent upon the input type and is defined in Appendix A.

## 1.7 MANUAL CONTROL MODE

If selection of Manual Control Mode is enabled, the Manual Control Mode may be entered (via a bumpless transfer) by depressing the Auto/Manual key. The **SET** indicator will then flash continuously whilst the Controller is in Manual Control Mode. The output power will then be displayed and may be adjusted with the Raise/Lower keys. A return can be made to Automatic Control Mode (via a bumpless transfer) by simply depressing the Auto/Manual key again, which causes the usual process variable display to appear.



## 1.8 PRE-TUNE FACILITY

This facility may be used to set the Controller's PID parameters to values which are approximately correct, in order to provide a base from which the Self-Tune facility may subsequently optimise tuning. Pre-Tune may be engaged (and subsequently dis-engaged) as follows:

### To engage:

- 1 With Controller showing a normal Operator Mode display:

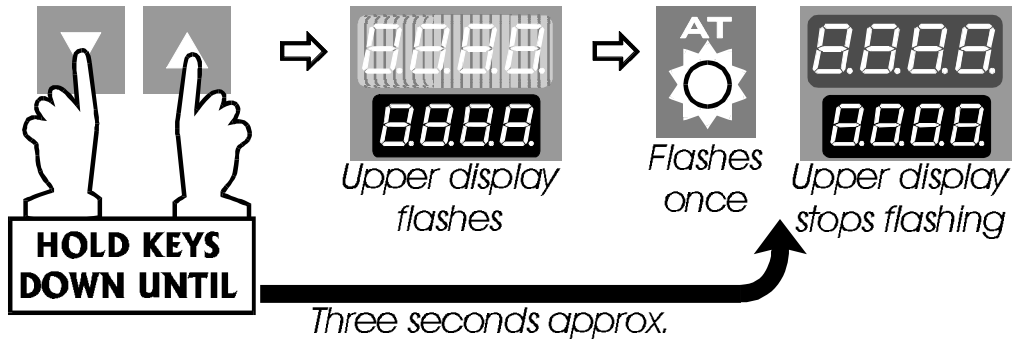

- 2 A hand presses the refresh key. The display shows 'AT' above a gear icon. Below it, it says 'Flashes whilst Pre-Tune is engaged'.

### To dis-engage:

- 1 With Controller showing a normal Operator Mode display:

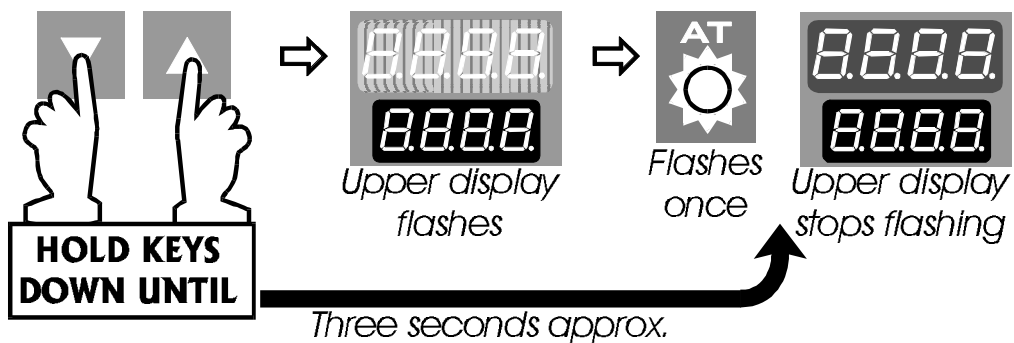

- 2 A hand presses the refresh key. The display shows 'AT' above a solid black circle. Below it, it says 'Goes OFF'.

NOTE: The Pre-Tune facility will not engage if (a) the setpoint is currently ramping, (b) the process variable is within 5% of input span of the setpoint, or (c) an erroneous key sequence is used.

Since Pre-Tune is a single-shot operation, it will automatically dis-engage itself once the operation is complete.



## 1.9 SELF-TUNE FACILITY

This facility is be used to optimise tuning whilst the Controller is operating. Self-Tune may be activated as follows:

### To engage:

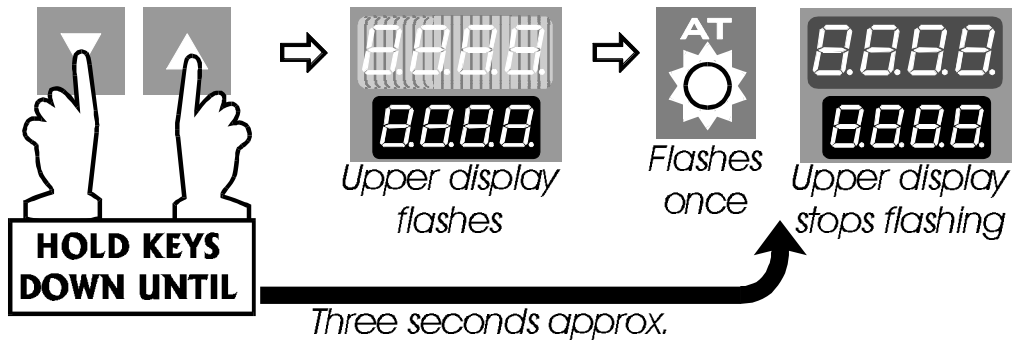
- 1 With Controller showing a normal Operator Mode display:





- 2  →  Flashes whilst Pre-Tune is engaged

### To dis-engage:

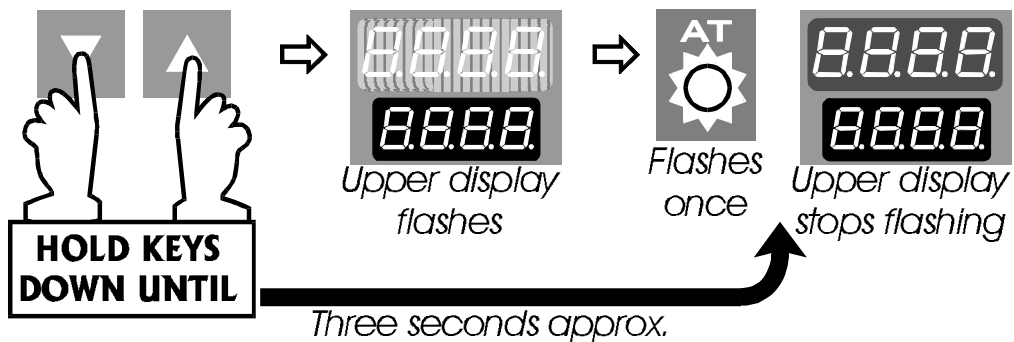
- 1 With Controller showing a normal Operator Mode display:



- 2  →  Goes OFF

### 1.10 VIEWING THE HARDWARE DEFINITION CODE

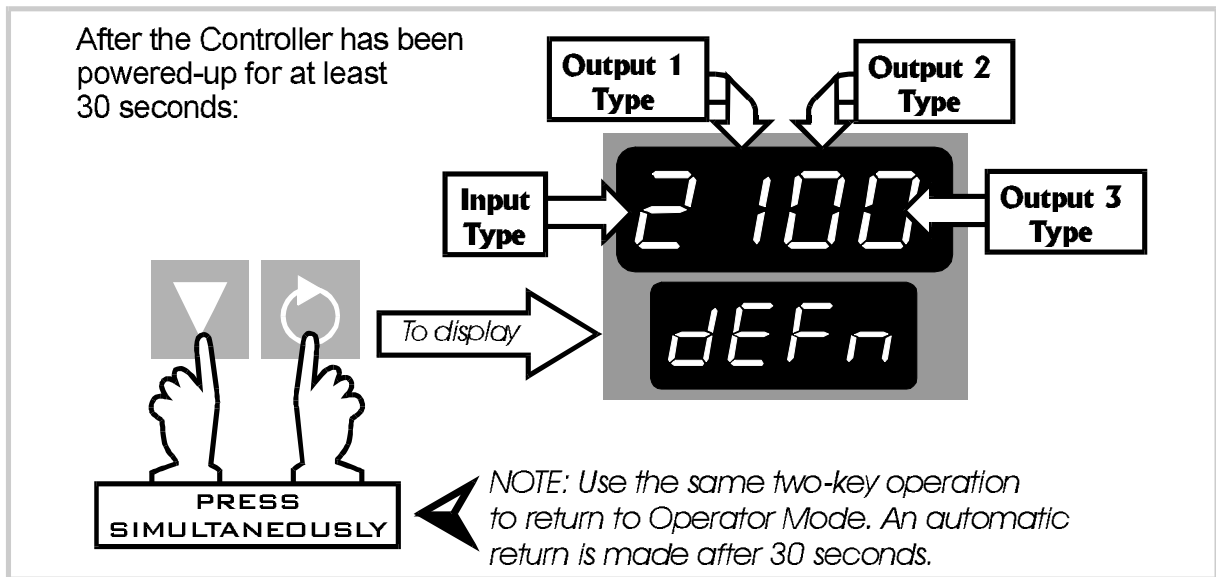

Figure 1-3 Viewing the Hardware Definition Code

**NOTE:** An automatic return is made to the normal Operator Mode display after 30 seconds.

The Hardware Definition Code has the following significance:

Value	0	1	2	3	4	5	7	8
Input		RTD/ Linear DC (mV)	Thermo- couple	Linear DC (mA)	Linear DC (V)			
Output 1		Relay	SSR Drive	DC (0 - 10V)	DC (0 - 20mA)	DC (0 - 5V)	DC (4 - 20mA)	Solid State
Output 2	Not fitted	Relay	SSR Drive	DC (0 - 10V)	DC (0 - 20mA)	DC (0 - 5V)	DC (4 - 20mA)	Solid State
Output 3	Not fitted	Relay	SSR Drive	DC (0 - 10V)	DC (0 - 20mA)	DC (0 - 5V)	DC (4 - 20mA)	Solid State

## 2 SET UP MODE

### 2.1 ENTRY INTO SET UP MODE

See Figure 2-1.

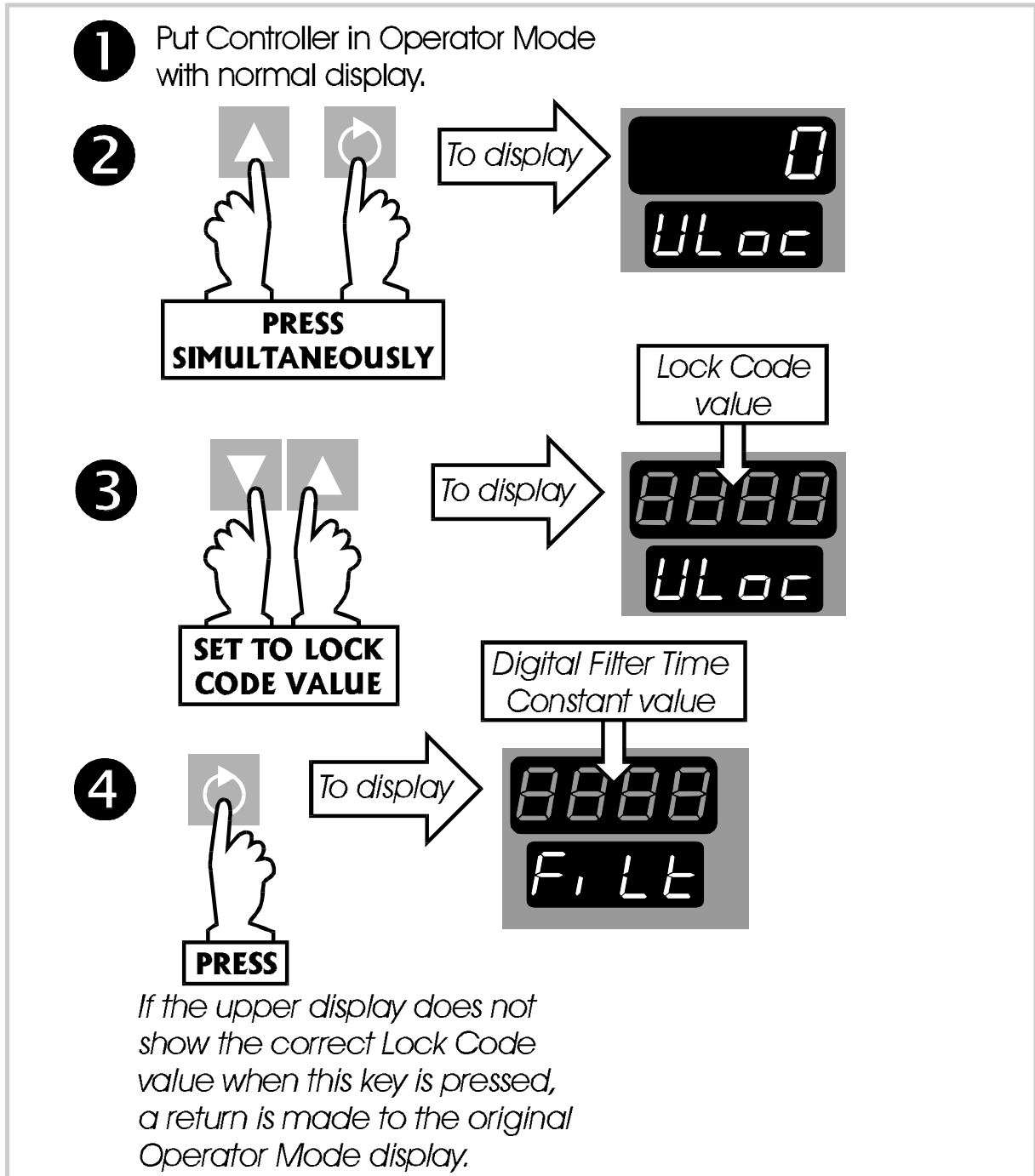
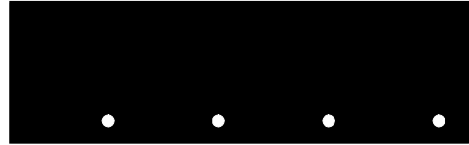

Figure 2-1 Entry into Set Up Mode

NOTE: If, on entry into Set Up Mode, the upper display initially shows all decimal point positions illuminated), this indicates that one or more of the critical configuration parameters - typically input range or output use/type - have been altered in value/setting and, as a consequence, all Set Up Mode parameters have been automatically set to their default values/settings. To clear this display, simply alter the value/setting of any Set Up Mode parameter (see below).



## 2.2 SET UP MODE PARAMETERS

The parameter sequence for view/adjustment in Set Up Mode is shown in Table 2-1. Use the Function key to step through the parameters. In each case, the legend will be shown in the lower display and the current value/setting will be shown in the upper display. The value/setting may be altered using the Raise/Lower keys. A detailed description of each of these parameters is given in the following Subsections.

### 2.2.1 Input Filter Time Constant

The Controller input is equipped with a digital filter which is used to filter out any extraneous impulses on the process variable. This filtered PV is used for all PV-dependent functions (control, alarms etc.).

CAUTION: If this parameter value is set excessively high, the control quality may be significantly impaired. The value chosen should be sufficiently large to attenuate stray noise on the process variable signal but no larger.

### 2.2.2 Process Variable Offset

This parameter is used to modify the actual process variable value (measured at the Controller's input terminals) in the following manner:

$$\text{Offset PV value} = \text{Actual PV value} + \text{Process Variable Offset value.}$$

For Controllers fitted with a linear input, the displayed process variable value is limited by Scale Range Maximum (see Subsection 2.2.30) and Scale Range Minimum (see Subsection 2.2.31). The offset process variable value is used for all PV-dependent functions (control, display, alarm, recorder output etc.).

NOTE: This parameter value should be chosen with care. Any adjustment to this parameter is, in effect, a calibration adjustment. Injudicious application of values to this parameter could lead to the displayed process variable value bearing no meaningful relationship to the actual process variable value. *There is no front panel indication when this parameter is in effect (i.e. has been set to a non-zero value).*

Table 2-1 Set Up Mode Parameters

Parameter	Legend	Adjustment Range	Default Value
Digital Filter Time Constant	<b>FILT</b>	OFF, 0.5 to 100.0 secs. In 0.5 sec. increments	2.0 seconds
Process Variable Offset	<b>OFFS</b>	±Span of Controller	0
Output Power	<b>OUT1</b>	0 to 100%	Read only
Output Power 2 <sup>5</sup>	<b>OUT2</b>	0 to 100%	Read only
Proportional Band 1	<b>Pb1</b>	0.0 (ON/OFF control) to 999.9% of input span	10.0%
Proportional Band 2 <sup>1,5</sup>	<b>Pb2</b>	0.0 (ON/OFF control) to 999.9% of input span	10.0%
Reset (Integral Time Const.) <sup>1</sup>	<b>RSET</b>	1s to 99m 59s and OFF	5m 00s
Rate (Derivative Time Const.) <sup>1</sup>	<b>RATE</b>	00s to 99m 59s	1m 15s
Overlap/Deadband <sup>1,5</sup>	<b>OL</b>	-20% to +20% (of Proportional Band 1 + Proportional Band 2)	0%
Manual Reset (Bias) <sup>1</sup>	<b>b, AS</b>	0% to 100% (Output 1 only) -100% to +100% (Output 1 & Output 2)	25%
ON/OFF Differential <sup>2</sup> Output 1 only	<b>d, F1</b>	0.1% to 10.0% of input span	0.5%
Output 2 only <sup>5</sup>	<b>d, F2</b>		
Output 3 only <sup>5</sup>	<b>d, FF</b>		
Setpoint High Limit	<b>SPH</b>	Setpoint to Range Maximum	Range Maximum
Setpoint Low Limit	<b>SPLO</b>	Range Minimum to Setpoint	Range Minimum
Recorder Output Scale Max.	<b>roPH</b>	-1999 to 9999	Range Maximum
Recorder Output Scale Min.	<b>roPL</b>	-1999 to 9999	Range Minimum
Output 1 Power Limit <sup>1</sup>	<b>OPH</b>	0% to 100% of full power	100%
Output 1 Cycle Time	<b>CT1</b>	0.5, 1, 2, 4, 8, 16, 32, 64, 128, 256 or 512 secs.	32 secs.
Output 2 Cycle Time	<b>CT2</b>	0.5, 1, 2, 4, 8, 16, 32, 64, 128, 256 or 512 secs.	32 secs.
Process High Alarm 1 value <sup>3</sup>	<b>h_A1</b>	Range Min. To Range Max.	Range Max.
Process Low Alarm 1 value <sup>3</sup>	<b>L_A1</b>	Range Min. To Range Max.	Range Min.
Band Alarm 1 value <sup>3</sup>	<b>b_A1</b>	0 to span from Limit SP	5 units
Deviation Alarm 1 value <sup>3</sup>	<b>d_A1</b>	±Span from Limit SP	5 units
Process High Alarm 2 value <sup>3</sup>	<b>h_A2</b>	Range Min. To Range Max.	Range Max.
Process Low Alarm 2 value <sup>3</sup>	<b>L_A2</b>	Range Min. To Range Max.	Range Min.
Band Alarm 2 value <sup>3</sup>	<b>b_A2</b>	0 to span from Limit SP	5 units
Deviation Alarm 2 value <sup>3</sup>	<b>d_A2</b>	±Span from Limit SP	5 units

Table 2-1 Set Up Mode Parameters (cont.)

Parameter	Legend	Adjustment Range	Default Value
Loop Alarm Enable	<b>LAEn</b>	0 (Disabled) or 1 (Enabled)	0
Loop Alarm Time <sup>6</sup>	<b>LAET</b>	1s to 99m 59s	99m 59s
Scale Range Decimal Point <sup>4</sup>	<b>rPnt</b>	0, 1, 2 or 3	1
Scale Range Maximum <sup>4</sup>	<b>rhi</b>	-1999 to 9999	1000
Scale Range Minimum <sup>4</sup>	<b>rLo</b>	-1999 to 9999	0000
Auto Pre-Tune Enable/Disable	<b>APt</b>	0 (Disabled) or 1 (Enabled)	0
Manual Control Enable/Disable	<b>POEn</b>	0 (Disabled) or 1 (Enabled)	0
Setpoint Ramp Enable/Disable	<b>rPEn</b>	0 (Disabled) or 1 (Enabled)	0
Setpoint Strategy	<b>SPSt</b>	1, 2, 3, 4 or 5	1
Communications Enable <sup>8</sup>	<b>CoEn</b>	0 (Disabled) or 1 (Enabled)	1 (Enabled)
Lock Code	<b>Loc</b>	0 to 9999	10
Operator Mode Displays (still accessible in Set Up Mode):			
Process Variable		Read Only	-
Setpoint <sup>10</sup>	<b>SP</b>	Setpoint Low Limit to Setpoint High Limit	Setpoint Low Limit
Ramping Setpoint value <sup>7</sup>	<b>SPrP</b>	Read only	
Setpoint Ramp Rate <sup>9</sup>	<b>rP</b>	1 to 9999 and OFF	OFF (blank)
Alarm Status	<b>ALSt</b>	Read Only (see Subsection 1.3)	-

NOTES ON TABLE 2-1

1. These parameters are not operative if the Proportional Band = 0.
2. Switching differential with ON/OFF control output
3. These parameters are optional; only one legend will appear for each alarm.
4. Only applicable if a DC Linear input is fitted.
5. Only applicable if Output 2 is fitted.
6. Only applicable if Proportional Band = 0.
7. Appears only if Ramp rate is not switched OFF.
8. Applicable only if the Communications Option PCB is fitted.
9. Does not appear in Operator Mode unless Setpoint Ramping is Enabled.
10. For Dual Setpoint operation, the legend displayed is SP1 or SP2, as appropriate.

### **2.2.3 Output Power 1**

This parameter is the current Output 1 power level. It is a Read Only parameter and is not adjustable.

### **2.2.4 Output Power 2**

This parameter is the current Output 2 power level (if Output 2 is fitted). It is a Read Only parameter and is not adjustable. If Output 2 is not fitted, this parameter display is not applicable.

### **2.2.5 Proportional Band 1**

This parameter is the portion of the input span of the Controller over which the Output 1 power level is proportional to the displayed process variable value. The function of the Proportional Band 1 is illustrated in Figure 2-2.

### **2.2.6 Proportional Band 2**

This parameter is the portion of the input span of the Controller over which the Output 2 power level is proportional to the displayed process variable value. In Figure 2-2, Proportional Band 2 is shown (a) with a non-zero value (Case 1 and Case 2) - PID control, and (b) with a zero value (Case 3) - ON/OFF control.

### **2.2.7 Reset (Integral Time Constant)**

This parameter is not applicable if Proportional Band 1 (see Subsection 2.2.5) is set to 0 (ON/OFF control).

### **2.2.8 Rate (Derivative Time Constant)**

This parameter is not applicable if Proportional Band 1 (see Subsection 2.2.5) is set to 0 (ON/OFF control).

### **2.2.9 Overlap/Deadband**

This defines the portion of the Proportional Band (Proportional Band 1 + Proportional Band 2) over which both outputs are active (or, in the case of a deadband, neither output is active). The function of the overlap/deadband is illustrated in Figure 2-2. This parameter is not applicable if Proportional Band 1 = 0 or if Output 2 is not fitted. Note that, with Output 2 set to ON/OFF control (Figure 3-2 Case 3), the Overlap/Deadband parameter has the effect of moving the ON Differential band of Output 2 to create an overlap (positive values) or a deadband (negative values). When Overlap/Deadband = 0, the Output 2 OFF edge of the Output 2 ON/OFF Differential band coincides with the point at which Output 1 reaches 0%.



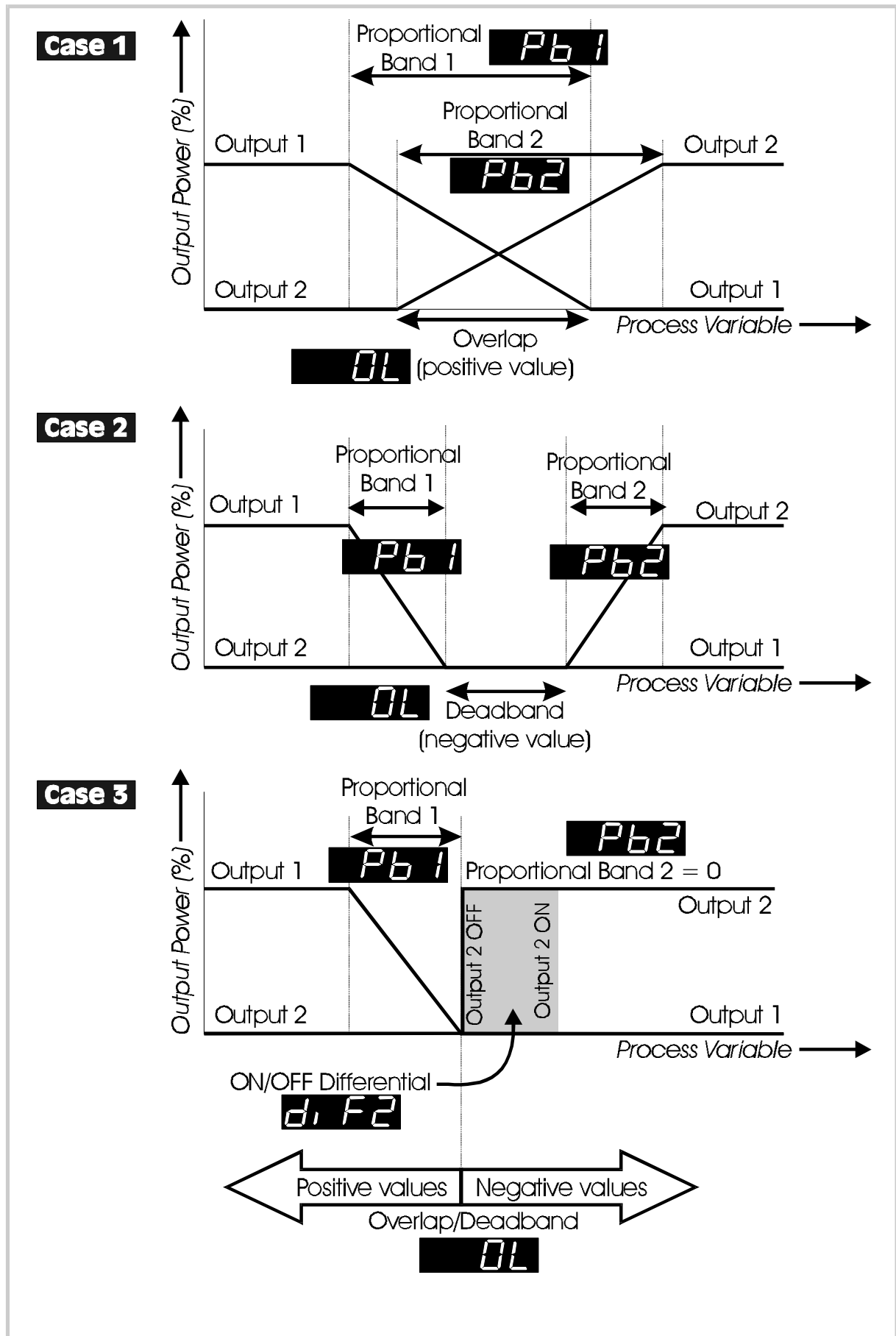

Figure 2-2 Proportional Band and Deadband/Overlap

### **2.2.10 Bias (Manual Reset)**

This bias to the output power is expressed as a percentage of output power. This parameter is not applicable if Proportional Band 1 = 0.

### **2.2.11 ON/OFF Differential**

This is a switching differential used when one or both outputs have been set to ON/OFF control (i.e. Proportional Band 1 or Proportional Band 2 or both = 0).

### **2.2.12 Setpoint High Limit**

This is the maximum limit for setpoint adjustment. It should be set to a value which prevents the setpoint being given a value which will cause damage to the process being controlled.

### **2.2.13 Setpoint Low Limit**

This is the minimum limit for setpoint adjustment. It should be set to a value which prevents the setpoint being given a value which will cause damage to the process being controlled.

### **2.2.14 Recorder Output Scale Maximum**

This parameter defines the value of process variable or setpoint (whichever is applicable) at which the Recorder Output reaches its maximum value; for example, for a 0 - 5V Recorder Output, this value corresponds to 5V. The decimal point position for the Recorder Output is always the same as that for the process variable input range. This parameter is not applicable if the Recorder Output option is not fitted.

NOTE: If this parameter is set to a value less than that for the Recorder Output Scale Minimum (see Subsection 2.2.15), the relationship between the process variable/setpoint value and the Recorder Output is reversed.

### **2.2.15 Recorder Output Scale Minimum**

This parameter defines the value of the process variable or setpoint (whichever is applicable) at which the Recorder Output reaches its minimum value; for example, for a 0 - 5V Recorder Output, this value corresponds to 0V. The decimal point position for the Recorder Output is always the same as that for the process variable input range. This parameter is not applicable if the Recorder Output option is not fitted.

NOTE: If this parameter is set to a value greater than that for the Recorder Output Scale Maximum (see Subsection 2.2.14), the relationship between the process variable value and the Recorder Output is reversed.

### **2.2.16 Output 1 Power Limit**

This parameter is used to limit the power level of Output 1 and may be used to protect the process being controlled. If no protection is required, this parameter may be set to 100%. This parameter is not applicable if Proportional Band 1 is set to 0.

### **2.2.17 Output 1 Cycle Time**

The cycle time value required is dependent upon the process being controlled and the type of output being used for Output 1. For a Relay Output, the cycle time should be as large as possible (whilst remaining compatible with the process control requirements) in order to maximise relay life. For an SSR Output, the cycle time may have a lower value (and thus satisfy the requirements of a fast-changing process variable e.g. flow or pressure). This parameter is not applicable if Proportional Band 1 is set to 0 or if Output 1 is a DC linear output..

### **2.2.18 Output 2 Cycle Time**

The cycle time value required is dependent upon the process being controlled and the type of output being used for Output 2. For a Relay Output, the cycle time should be as large as possible (whilst remaining compatible with the process control requirements) in order to maximise relay life. For an SSR Output, the cycle time may have a lower value (and thus satisfy the requirements of a fast-changing process variable e.g. flow or pressure). This parameter is not applicable if Proportional Band 1 or Proportional Band 2 is set to 0 or if Output 2 is a DC linear output.

### **2.2.19 Process High Alarm 1 Value**

This parameter, applicable only when Alarm 1 is selected to be a Process High alarm, defines the process variable value at or above which Alarm 1 will be active. The operation of a process high alarm is illustrated in Figure 2-3.

### **2.2.20 Process Low Alarm 1 Value**

This parameter, applicable only when Alarm 1 is selected to be a Process Low alarm, defines the process variable value at or below which Alarm 1 will be active. The operation of a process low alarm is illustrated in Figure 2-3.

### **2.2.21 Band Alarm 1 Value**

This parameter, applicable only if Alarm 1 is selected to be a Band Alarm, defines a band of process variable values, centred on the setpoint value. If the process variable value is outside this band, the alarm will be active. The operation of a band alarm is illustrated in Figure 2-3.

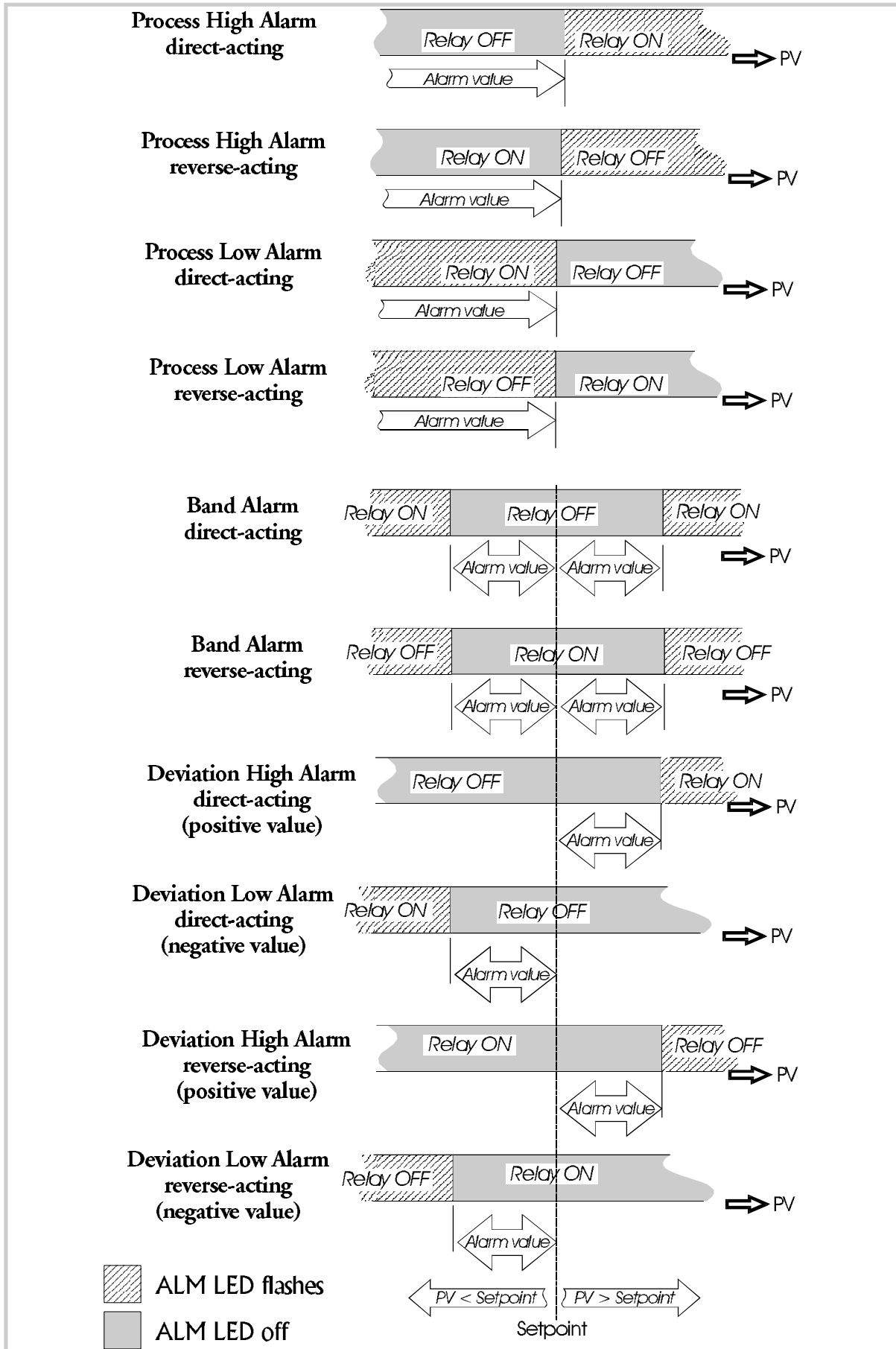

Figure 2-3 Alarm Operation

### **2.2.22 Deviation (High/Low) Alarm 1 Value**

This parameter, applicable only if Alarm 1 is selected to be a Deviation High/Low Alarm, defines a value above (positive value - Deviation High alarm) or below (negative value - Deviation Low alarm) the setpoint; if the process variable deviates from the setpoint by a margin greater than that defined by this parameter, Alarm 1 goes active. The operation of Deviation Alarms is illustrated in Figure 2-3.

### **2.2.23 Process High Alarm 2 Value**

This parameter, applicable only when Alarm 2 is selected to be a Process High alarm, defines the process variable value at or above which Alarm 2 will be active. The operation of a process high alarm is illustrated in Figure 2-3.

### **2.2.24 Process Low Alarm 2 Value**

This parameter, applicable only when Alarm 2 is selected to be a Process Low alarm, defines the process variable value at or below which Alarm 2 will be active. The operation of a process low alarm is illustrated in Figure 2-3.

### **2.2.25 Band Alarm 2 Value**

This parameter, applicable only if Alarm 2 is selected to be a Band Alarm, defines a band of process variable values, centred on the setpoint value. If the process variable value is outside this band, the alarm will be active. The operation of a band alarm is illustrated in Figure 2-3.

### **2.2.26 Deviation (High/Low) Alarm 2 Value**

This parameter, applicable only if Alarm 2 is selected to be a Deviation High/Low Alarm, defines a value above (positive value - Deviation High alarm) or below (negative value - Deviation Low alarm) the setpoint; if the process variable deviates from the setpoint by a margin greater than that defined by this parameter, Alarm 2 goes active. The operation of Deviation Alarms is illustrated in Figure 2-3.

### **2.2.27 Loop Alarm Enable**

This parameter is the means by which the user can enable or disable the Loop Alarm. The Loop Alarm is a special alarm which detects faults in the control feedback loop by continuously monitoring process variable response to the control output(s).

The Loop Alarm facility, when enabled, repeatedly checks the control output(s) for saturation i.e. either or both outputs being at the maximum or minimum limit. If an output is found to be in saturation, the Loop Alarm facility starts a timer; thereafter,

if the saturated output has not caused the process variable to be corrected by a pre-determined amount V after a time T has elapsed, the Loop Alarm goes active. Subsequently, the Loop Alarm facility repeatedly checks the process variable and the control output(s). When the process variable starts to change value in the correct sense or when the saturated output comes out of saturation, the Loop Alarm is de-activated.

For PID control, the Loop Alarm Time T is always set to twice the value of the Reset (Integral Time Constant) parameter. For On/Off control, the user-defined value of the Loop Alarm Time Set Up parameter (see Subsection 2.2.28) is used.

The value of V is dependent upon the input type:

°C ranges:	2°C or 2.0°C
°F ranges:	3°F or 3.0°F
Linear ranges:	10 least significant display units

For single output Controllers, the saturation limits are 0% and Out1Max%. For dual output Controllers, the saturation limits are 100% and Out1Max%.

#### NOTES

1. Correct operation of the Loop Alarm depends upon reasonably accurate PID tuning.
2. The Loop Alarm is automatically disabled during Manual Control Mode and during execution of the Pre-Tune facility. Upon exit from Manual Control Mode or after completion of the Pre-Tune routine, the Loop Alarm is automatically re-enabled.

## 2.2.28 Loop Alarm Time

When full ON/OFF control is selected (i.e. Proportional Band 1 is set to 0) and Loop Alarm is enabled, this parameter determines the duration of the saturation condition after which the Loop Alarm will be activated. This parameter is omitted from the Set Up display sequence if ON/OFF control is not selected or Loop Alarm is disabled.

## 2.2.29 Scale Range Decimal Point

This parameter, applicable only if a linear input is fitted, defines the position of the decimal point in values of the process variable, setpoint, alarm levels and recorder outputs as shown on the right.

Value	Decimal Point Position
0	xxxx
1	xxx.x
2	xx.xx
3	x.xxx

### **2.2.30 Scale Range Maximum**

This parameter, applicable only if a linear input is fitted, defines the scaled input value when the process variable input hardware is at its maximum value. This parameter can be set to a value less than (but not equal to) Scale Range Minimum, in which case the sense of the input is reversed. Decimal point position is defined by the Scale Range Decimal Point parameter (see Subsection 2.2.29).

### **2.2.31 Scale Range Minimum**

This parameter, applicable only if a linear input is fitted, defines the scaled input value when the process variable input hardware is at its minimum value. This parameter can be set to a value greater than (but not equal to) Scale Range Maximum, in which case the sense of the input is reversed. Decimal point position is defined by the Scale Range Decimal Point parameter (see Subsection 2.2.29).

### **2.2.32 Auto Pre-Tune Enable/Disable**

This parameter determines whether or not the Controller's Pre-Tune facility is activated automatically on power-up or not.

### **2.2.33 Manual Control Enable/Disable**

This parameter determines whether operator selection of manual control is enabled or disabled.

### **2.2.34 Setpoint Ramp Enable/Disable**

This parameter enables/disables use of the setpoint ramping feature at user level.

### **2.2.35 Setpoint Strategy**

This parameter enables the user to select the required Operator Mode setpoint display strategy - see Subsections 1.2.1 (Single Setpoint operation) and 1.2.2 (Dual Setpoint operation).

### **2.2.36 Communications Enable/Disable**

This parameter enables/disables Write operations (i.e. the *changing* of parameter values/settings) via the RS485 communications link, if the Communications Option PCB is fitted. Parameters can be *interrogated* via the link, regardless of the setting of this parameter.

### **2.2.37 Lock Value**

This parameter defines the four-digit code required to enter Set Up Mode.

## 2.3 OPERATOR MODE DISPLAYS

Once the complete cycle of Set Up Mode parameters has been displayed, the user may then step through the Operator Mode displays (see Section 1), making adjustments where required, before re-starting the Set Up Mode parameter cycle, as shown in Table 2-1.

## 2.4 TUNING THE CONTROLLER MANUALLY

### 2.4.1 Controllers Fitted with Output 1 Only

Before starting to tune the Controller to the load, check that the Setpoint High and Low Limits (**SPhi** and **SPLo**) are set to safe levels - see Subsections 2.2.12 and 2.2.13.

The following simple technique may be used to determine values for proportional band (**Pb1**), derivative time constant (**rAtE**) and integral time constant (**rSEt**).

**NOTE:** This technique is suitable only for processes which are not harmed by large fluctuations in the process variable. It provides an acceptable basis from which to start fine tuning for a wide range of processes.

1. Set the setpoint to the normal operating process value (or to a lower value if overshoot beyond this value is likely to cause damage).

2. Select ON/OFF Control (i.e. set **Pb1** = 0).

3. Switch on the process. The process variable will oscillate about the setpoint. Note (a) The peak-to-peak variation (**P**) of the first cycle i.e. the difference between the highest value of the first overshoot and the lowest value of the first undershoot, and (b) The cycle time (**T**) of this oscillation in minutes (see Figure 2-4)

4. The control parameters should then be set as follows:

$$\mathbf{Pb1} = \frac{P}{ScaleRange} \times 100$$

$$\mathbf{rSEt} = T \text{ minutes}$$

$$\mathbf{rAtE} = \frac{T}{6} \text{ minutes}$$

**NOTE:** After setting up the parameters, set the Controller to Operator Mode (see Subsection 2.6) to prevent unauthorised adjustment to the values.



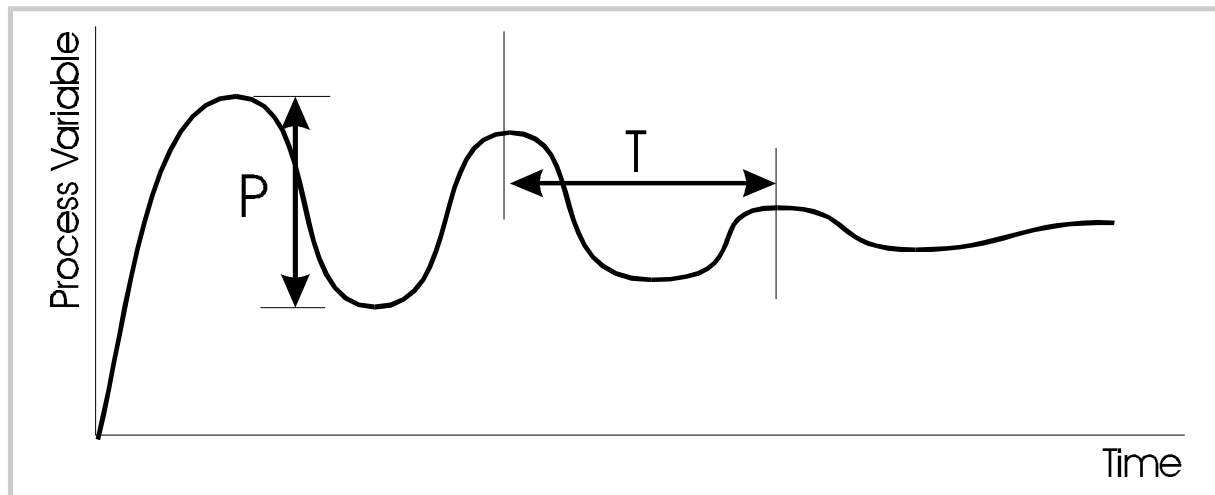

Figure 2-4 Manual Tuning Parameters - Output 1 only

## 2.4.2 Controllers Fitted with Output 1 and Output 2

Before starting to tune the Controller to the load, check that the Setpoint High and Low Limits (**SPhi** and **SPLo**) are set to safe levels - see Subsections 2.2.12 and 2.2.13.

The following simple technique may be used to determine values for proportional band (**Pb1**), derivative time constant (**rAtE**) and integral time constant (**rSEt**).

NOTE: This technique is suitable only for processes which are not harmed by large fluctuations in the process variable. It provides an acceptable basis from which to start fine tuning for a wide range of processes.

1. Tune the Controller using Output 1 only as described in Subsection 2.4.1.
2. Set **Pb2** to the same value as **Pb1** and monitor the operation of the Controller in dual output mode. If there is a tendency to oscillate as control passes into the Output 2 proportional band, increase the value of **Pb2**. If the process appears to be over-damped in the region of the Output 2 proportional band, decrease the value of **Pb2**.
3. When values of proportional bands, integral time constant and derivative time constant have been determined for tuning, if there is a kick as control passes from one output to the other, set **OL** to a positive value to introduce some overlap. Adjust the value of **OL** by trial and error until satisfied.

## 2.5 SELF-TUNE AND PRE-TUNE FACILITIES

Once the Controller has been manually tuned, the Self-Tune and Pre-Tune facilities may be used in Operator Mode to enhance further the response of the Controller (see Subsections 1.8 and 1.9).

## **2.6 EXIT FROM SET UP MODE**

To leave Set Up Mode, select the initial Operator Mode display (normally process variable) then depress the Raise and Function keys simultaneously, whereupon the Controller will return to Operator Mode. NOTE: An automatic return to Operator mode will be executed if there is no key activity in Set Up Mode for two minutes.

## **3 RS485 SERIAL COMMUNICATIONS**

The Controller may be equipped with a two-wire RS485-compatible serial communications facility, by which means communication may occur between the Controller and a master device (e.g. a computer or terminal).

### **3.1 COMMUNICATIONS ENABLE/DISABLE**

When Communications are enabled (in Set Up Mode - see Subsection 2.2.36), the Controller parameters may be adjusted by the master device via the serial communications link. If communications are disabled, the Controller will not adjust or change any parameters in response to commands received from the master device and will send a negative acknowledgement in response to such commands. Whether communications are enabled or disabled, the Controller will return the requested information in response to a Type 2 Interrogation message (see Subsection 3.2.5) from the master device.

### **3.2 PHYSICAL REQUIREMENTS**

#### **3.2.1 Character Transmission**

Data format is fixed to be even parity, seven data bits and one stop bit. The Baud rate may be selected to be 1200, 2400, 4800 (default) or 9600 Baud.

#### **3.2.2 Line Turn-Round**

The communications link is operated as a multi-drop half duplex system. When a device is transmitting, it drives the transmission lines to the appropriate levels; when it is not transmitting, its outputs are set to a high impedance in order that another device can transmit. It is important that a transmitter releases the transmission lines before another device starts transmission. This imposes the following restraints on the master device:

(a) The transmitter must release the transmission lines within 6ms of the end of the last character of a message being transmitted. Note that delays due to buffers such as those used in universal asynchronous receivers/transmitters (UARTs) within the master device must be taken into account.

(b) The transmitter must not start transmission until 6ms has elapsed since the reception of the last character of a message.

All Controllers in this range having an RS485 communications facility adhere to this standard; thus, provided that the master device conforms similarly to the standard, there should be no line contention problems.

### 3.2.3 Communications Protocol

The protocol assumes half duplex communications. All communication is initiated by the master device. The master sends a command or query to the addressed slave and the slave replies with an acknowledgement of the command or the reply to the query. All messages, in either direction, comprise:

- (a) A Start of Message character
- (b) One or two address characters (uniquely defining the slave)
- (c) A parameter/data character string
- (d) An End of Message character

Messages from the master device may be one of four types:

- Type 1: L {N} ? ? \*
- Type 2: L {N} {P} {C} \*
- Type 3: L {N} {P} # {DATA} \*
- Type 4: L {N} {P} I \*

Table 3-1 {DATA} Element - Sign and Decimal Point

{DATA} Content	Sign/Decimal Point
abcd0	+abcd
abcd1	+abc.d
abcd2	+ab.cd
abcd3	+a.bcd
abcd5	-abcd
abcd6	-abc.d
abcd7	-ab.cd
abcd8	-a.bcd

where all characters are in ASCII code and:

- L is the Start of Message character (Hex 4C)
- {N} is the slave Controller address (in the range 1 - 32); addresses 1 - 9 may be represented by a single digit (e.g. 7) or in two-digit form, the first digit being zero (e.g. 07).

{P} is a character which identifies the parameter to be interrogated/modified.

{C} is the command (see below)

# indicates that {DATA} is to follow (Hex 23)

{DATA} is a string of numerical data in ASCII code (see Table 3-1)

\* is the End of Message character (Hex 2A)

No space characters are permitted in messages. Any syntax errors in a received message will cause the slave controller to issue no reply and await the Start of Message character.

### 3.2.4 Type 1 Message

**L {N} ? ? \***

This message is used by the master device to determine whether the addressed slave Controller is active. The reply from the slave Controller, if it is active, is

**L {N} ? A \***

An inactive Controller will give no reply.

### 3.2.5 Type 2 Message

**L {N} {P} {C} \***

This type of message is used by the master device to interrogate or modify a parameter in the addressed Controller. {P} identifies the parameter and {C} represents the command to be executed, which may be one of the following:

- + (Hex 2B) - Increment the value of the parameter defined by {P}
- (Hex 2D) - Decrement the value of the parameter defined by {P}
- ? (Hex 3F) - Determine the current value of the parameter defined by {P}

The reply from the addressed Controller is of the form:

**L {N} {P} {DATA} A \***

where {DATA} comprises five ASCII-coded digits whose format is shown in Table 3-1. The data is the value requested in a query message or the new value of the parameter after modification. If the action requested by the message from the master device would result in an invalid value for that parameter (either because the requested new value would be outside the permitted range for that parameter or because the parameter is not modifiable), the Controller replies with a negative acknowledgement:

**L {N} {P} {DATA} N \***

The {DATA} string in the negative acknowledgement reply will be indeterminate. If the process variable or the deviation is interrogated whilst the process variable is outside the range of the Controller, the reply is **L{N}{P}<??>0A\*** if the process variable is over-range, or **L{N}{P}<??>5A\*** if the process variable is under-range.

### Scan Tables

A parameter identifier character ] in the message from the master device indicates that a Scan Table operation is required. This provides a facility for

interrogating the values of a group of parameters and status in a single message from the master device. The reply to such a command would be in the form:

**L {N} ] xx aaaaa bbbbb ccccc ddddd eeeee A \***

where xx is the number of data digits to follow; this is 20 for a single-control-output instrument and 25 for a dual-control-output instrument. The digits are expressed as shown in Table 3-1. For further information, refer to Subsection 3.3.6.

### 3.2.6 Type 3 Message

**L {N} {P} # {DATA} \***

This message type is used by the master device to set a parameter to the value specified in {DATA}. The command is not implemented immediately by the slave Controller; the slave will receive this command and will then wait for a Type 4 message (see below). Upon receipt of a Type 3 message, if the {DATA} content and the specified parameter are valid, the slave Controller reply is of the form:

**L {N} {P} {DATA} I \***

(where I = Hex 49) indicating that the Controller is ready to implement the command. If the parameter specified is invalid or is not modifiable or if the desired value is outside the permitted range for that parameter, the Controller replies with a negative acknowledgement in the form:

**L {N} {P} {DATA} N \***

### 3.2.7 Type 4 Message

**L {N} {P} I \***

This type of message is sent by the master device to the addressed slave Controller following a successful Type 3 message transmission and reply to/from the same slave Controller. Provided that the {DATA} content and the parameter specified in the preceding Type 3 message are still valid, the slave Controller will then set the parameter to the desired value and will reply in the form:

**L {N} {P} {DATA} A \***

where {DATA} is the new value of the parameter. If the new value or parameter specified is invalid, the slave Controller will give a negative acknowledgement:

**L {N} {P} {DATA} N \***

where {DATA} is indeterminate. If the immediately-preceding message received by the slave Controller was not a Type 3 message, the Type 4 message is ignored.

### 3.3 INDIVIDUAL PARAMETERS

The individual parameters and how they may be interrogated/modified are described below. Unless otherwise stated, the {DATA} element will follow the standard five-digit format and the decimal point position must be correct for the new value to be accepted and for modification to occur.

NOTE: The communications identifier character {P} for each parameter is shown to the right of each subsection heading.

#### 3.3.1 Input Parameters

Parameter	Identifier	Description
Process Variable	M	Read (Type 2 message) Only; If out of range, {DATA} will contain <??>0 (over-range) or <??>5 (under-range).
Process Variable Offset	v	May be read (Type 2 message) or modified (Type 3/Type 4 message sequence). Modifies actual process variable value (as measured at the input terminals): Modified PV value = Actual PV value + PV offset value Modified value is limited by Range Maximum and Range Minimum and is used for display/alarm purposes and for recorder outputs. <i>Choose this value with care. In effect, it modifies the Controller's calibration. Lack of care could result in the displayed PV value having no meaningful relationship to the actual PV value.</i>
Scale Range Max.	G	Adjustable only on DC inputs. May be read (Type 2 message) or modified (Type 3/Type 4 message sequence). Decimal point position is as for the input range. <i>If less than Scale Range Min. Value, sense of input is reversed.</i>
Scale Range Min.	H	Adjustable only on DC inputs. May be read (Type 2 message) or modified (Type 3/Type 4 message sequence). Decimal point position is as for the input range. <i>If greater than Scale Range Max. Value, sense of input is reversed.</i>
Scale Range Decimal Point	Q	Adjustable on DC inputs only. May be read (Type 2 message) or modified (Type 3/Type 4 message sequence). Defines the decimal point position: 0 = abcd    1 = abc.d    2 = ab.cd 3 = a.bcd
Input Filter Time Constant	m	May be read or modified using a Type 2 message or a Type 3/Type 4 message sequence.

### 3.3.2 Output Parameters

Parameter	Identifier	Description
Power Output value	W	If Manual Control is not selected, may be read only (Type 2 message). If Manual Control is selected, may be read (Type 2 message) or modified (Type 3/Type 4 message sequence).
Output 1 Power Limit	B	May be read (Type 2 message) or modified (Type 3/Type 4 message sequence). Defines power limit for Output 1.
Output 1 Cycle Time	N	May be read (Type 2 message) or modified (Type 3/Type 4 message sequence). NOTE: Value must be a power of 2 in the range 0.5 - 512 (i.e. 0.5, 1, 2, 4, 8 etc.). For a Relay Output, cycle time should be as large as possible (whilst remaining compatible with the process control requirements) in order to maximise relay life. For an SSR Output, the cycle time may have a lower value (and thus satisfy the requirements of a fast-changing process variable e.g. flow or pressure).
Output 2 Cycle Time	O	May be read (Type 2 message) or modified (Type 3/Type 4 message sequence). NOTE: Value must be a power of 2 in the range 0.5 - 512 (i.e. 0.5, 1, 2, 4, 8 etc.). For a Relay Output, cycle time should be as large as possible (whilst remaining compatible with the process control requirements) in order to maximise relay life. For an SSR Output, the cycle time may have a lower value (and thus satisfy the requirements of a fast-changing process variable e.g. flow or pressure).
Recorder Output Scale Max.	[	May be read/modified by a Type 2 message or a Type 3/Type 4 message sequence. Corresponds to Input Scale Max. with decimal point position as for input. If less than Recorder Output Scale Min. sense of recorder output is reversed.
Recorder Output Scale Min.	\	May be read/modified by a Type 2 message or a Type 3/Type 4 message sequence. Corresponds to Input Scale Min. with decimal point position as for input. If greater than Recorder Output Scale Max. sense of recorder output is reversed.



### 3.3.3 Setpoint Parameters

Parameter	Identifier	Description
Setpoint value	S	May be read (Type 2 message) or modified (Type 3/Type 4 message sequence). Limited by Setpoint High Limit and Setpoint Low Limit (see below).
Setpoint Ramp Rate	^	May be read (Type 2 message) or modified (Type 3/Type 4 message sequence). May be set in the range 1 - 9999 increments/hour or OFF ({DATA} =0000). Decimal point position is as for input range.
Setpoint High Limit	A	May be read (Type 2 message) or modified (Type 3/Type 4 message sequence). Defines maximum value for setpoint (in the range setpoint - Input Range Maximum). Decimal point position is as for input range.
Setpoint Low Limit	T	May be read (Type 2 message) or modified (Type 3/Type 4 message sequence). Defines minimum value for setpoint (in the range Input Range Minimum - setpoint). Decimal point position is as for input range.

### 3.3.4 Alarm Parameters

Parameter	Identifier	Description
Alarm 1 value	C	May be read/modified by a Type 2 message or a Type 3/Type 4 message sequence. Decimal point position is as for input range.
Alarm 2 value	E	May be read/modified by a Type 2 message or a Type 3/Type 4 message sequence. Decimal point position is as for input range.

For descriptions of the operation of the different alarm types, see Figure 2-2.

### 3.3.5 Tuning Parameters

Parameter	Identifier	Description
Rate (Derivative Time Constant)	D	May be read/modified using a Type 2 message or a Type 3/Type 4 message sequence. Defines the derivative time constant for the control algorithm. {DATA} is of the form mm.ss where mm = minutes and ss = seconds. The decimal point position must specify two decimal places, otherwise modification will not occur.
Reset (Integral Time Constant)	I	May be read/modified using a Type 2 message or a Type 3/Type 4 message sequence. Defines the integral time constant for the control algorithm. {DATA} is of the form mm.ss where mm = minutes and ss = seconds. The decimal point position must specify two decimal places, otherwise modification will not occur. <sup>1</sup>
Manual Reset (Bias)	J	May be read/modified using a Type 2 message or a Type 3/Type 4 message sequence. Decimal point position is as for input range.
ON/OFF Differential	F	May be read/modified using a Type 2 message or a Type 3/Type 4 message sequence. Defines the switching hysteresis for controllers with an ON/OFF control output. Decimal point position = 1.
Overlap /Deadband	K	May be read/modified using a Type 2 message or a Type 3/Type 4 message sequence. May be set to a positive (overlap) or negative (deadband) value. Decimal point position = 0. <sup>2</sup>
Proportional Band 1 value	P	May be read/modified using a Type 2 message or a Type 3/Type 4 message sequence. May be set to 0.0 (ON/OFF control) or within the range 0.5% - 999.9% of Output 1 power range. Decimal point position = 1.
Proportional Band 2 value	U	May be read/modified using a Type 2 message or a Type 3/Type 4 message sequence. May be set to 0.0 (ON/OFF control) or within the range 0.5% - 999.9% of Output 2 power range. Decimal point position = 1. <sup>2</sup>

1. If controller is in ON/OFF control mode (i.e. Proportional Band 1 = 0) and Loop Alarm is enabled (see Subsection 2.2.27), a message with identifier I will have effect on the Loop Alarm Time parameter, not the Integral Time Constant.

2. Not applicable to controllers with only one control output.

### 3.3.6 Status Parameters

Parameter	Identifier	Description												
Controller Status	L	Read Only (Type 2 message). Status information is encoded in four digits as the decimal representation of a binary number; each bit in the binary number has a particular significance (see Figure 3-1).												
Arithmetic Deviation	V	Read Only (Type 2 message). The difference between the process variable value and the Limit Setpoint value.												
Scan Tables	]	Read Only (Type 2 message). Response: L{N}xxxxaaabbbbbbccccddddddeeeeeA* where: <table style="margin-left: 40px;"> <tr> <td>xx =</td> <td>Number of data digits in {DATA} element (20 for single control output, 25 for dual control outputs)</td> </tr> <tr> <td>aaaaa =</td> <td>Current setpoint value</td> </tr> <tr> <td>bbbbbb =</td> <td>Current process variable value</td> </tr> <tr> <td>cccccc =</td> <td>Current value of Output 1 Power (0 - 100%)</td> </tr> <tr> <td>dddddd =</td> <td>Current value of Output 2 Power (0 - 100%) - if applicable.</td> </tr> <tr> <td>eeeeee =</td> <td>Controller Status (see Figure 3-1)</td> </tr> </table>	xx =	Number of data digits in {DATA} element (20 for single control output, 25 for dual control outputs)	aaaaa =	Current setpoint value	bbbbbb =	Current process variable value	cccccc =	Current value of Output 1 Power (0 - 100%)	dddddd =	Current value of Output 2 Power (0 - 100%) - if applicable.	eeeeee =	Controller Status (see Figure 3-1)
xx =	Number of data digits in {DATA} element (20 for single control output, 25 for dual control outputs)													
aaaaa =	Current setpoint value													
bbbbbb =	Current process variable value													
cccccc =	Current value of Output 1 Power (0 - 100%)													
dddddd =	Current value of Output 2 Power (0 - 100%) - if applicable.													
eeeeee =	Controller Status (see Figure 3-1)													

### 3.3.7 Controller Commands

Parameter	Identifier	Description																
Controller Commands	Z	Implemented by Type 3/Type 4 message sequence only. In the Type 3 message, {DATA} must be one of eight five-digit numbers: <table style="margin-left: 40px;"> <tr> <td>00010</td> <td>Activate Manual Control</td> </tr> <tr> <td>00020</td> <td>Activate Automatic Control</td> </tr> <tr> <td>00030</td> <td>Activate Self-Tune</td> </tr> <tr> <td>00040</td> <td>De-activate Self-Tune</td> </tr> <tr> <td>00050</td> <td>Request Pre-Tune*</td> </tr> <tr> <td>00060</td> <td>Abort Pre-Tune</td> </tr> <tr> <td>00130</td> <td>Activate Loop Alarm</td> </tr> <tr> <td>00140</td> <td>De-activate Loop Alarm</td> </tr> </table> <p>The response from the Controller also contains the same {DATA} content, as does the response to the Type 4 message.</p>	00010	Activate Manual Control	00020	Activate Automatic Control	00030	Activate Self-Tune	00040	De-activate Self-Tune	00050	Request Pre-Tune*	00060	Abort Pre-Tune	00130	Activate Loop Alarm	00140	De-activate Loop Alarm
00010	Activate Manual Control																	
00020	Activate Automatic Control																	
00030	Activate Self-Tune																	
00040	De-activate Self-Tune																	
00050	Request Pre-Tune*																	
00060	Abort Pre-Tune																	
00130	Activate Loop Alarm																	
00140	De-activate Loop Alarm																	

\* Pre-Tune will be activated only if the process variable is at least 5% of input span from the setpoint.

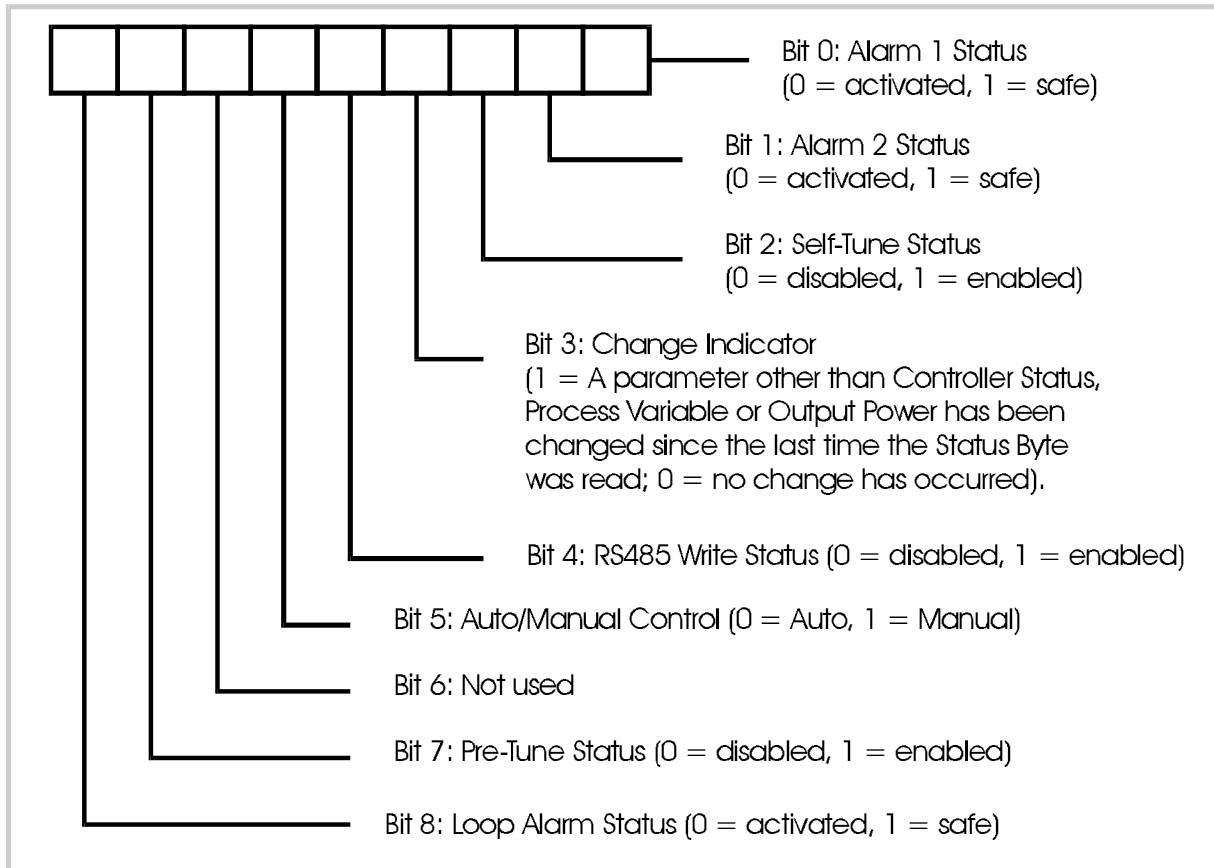

Figure 3-1 Controller Status Byte

### 3.4 ERROR RESPONSE

The circumstances under which a message received from the master device is ignored are:

- Parity error detected
- Syntax error detected
- Timeout elapsed
- Receipt of a Type 4 message without a preceding Type 3 command message.

Negative acknowledgements will be returned if, in spite of the received message being notionally correct, the Controller cannot supply the requested information or perform the requested operation. The {DATA} element of a negative acknowledgement will be indeterminate.

# ALPHABETIC INDEX - VOLUME 1

## A

Alarm 1 Value	
Band Alarm	2-3
Deviation Alarm	2-3
Process High Alarm	2-3
Process Low Alarm	2-3
Alarm 2 Value	
Band alarm	2-3
Deviation alarm	2-3
Process High alarm	2-3
Process Low alarm	2-3
Alarm Operation	
Illustration of	2-9
Alarm Status	
Display of	1-3
Displaying (Set Up mode)	2-4
Auto Pre-Tune Enable/Disable	2-12

## B

Band Alarm 1	2-8
Band Alarm 2	2-10
Bias (Manual Reset)	2-7

## C

Communications Line Release Time	
Maximum Value	3-1
Communications Message	
Format	3-2

## D

Deadband	2-5
Decimal Point Position	
Input scale range	2-4
Derivative Time Constant (Rate)	2-5
Deviation Alarm 1	2-10
Deviation Alarm 2	2-10
Digital Filter Time Constant	2-3

## H

Hardware Definition Code	
Explanation of	1-7
Viewing	1-7

## I

Input Filter Time Constant	2-2
Input Over-Range	
Indication of	1-4
Input Scale Range	
Decimal point position	2-4
Input Scale Range Maximum	2-4
Input Scale Range Minimum	2-4
Input Under-Range	
Indication of	1-4
Integral Time Constant (Reset)	2-5

## L

Lock Value	2-12
Loop Alarm	2-10
Loop Alarm Enable	2-10
Loop Alarm Time	2-11

## M

Manual Control Mode	
De-selection of	1-4
Indication of	1-4
Selection of	1-4
Manual Control Selection	
Enable/Disable	2-12
Manual Reset (Bias)	2-7
Manual Tuning	
Controllers with Output 1 and	
Output 2	2-14
Controllers with	
Output 1 only	2-13

**O**

ON/OFF Differential	2-7
Output 1 Cycle Time	2-8
Output 1 Power Limit	2-8
Output 2 Cycle Time	2-8
Output Power 1	2-5
Output Power 2	2-5
Overlap	2-5

**P**

Pre-Tune Facility	
Activation of	1-5
Process High Alarm 1	2-8
Process High Alarm 2	2-10
Process Low Alarm 1	2-8
Process Low Alarm 2	2-10
Process Variable Offset	2-2
Proportional Band 1	2-5
Proportional Band 2	2-5

**R**

Rate (Derivative Time Constant)	2-5
Recorder Output Scale Maximum	2-7
Recorder Output Scale Minimum	2-7
Reset	2-5
Reset (Integral Time Constant)	2-5

**S**

Scale Range Decimal Point	2-11
Scale Range Maximum	2-12
Scale Range Minimum	2-12
Self-Tune Facility	
Activation of	1-6
Sensor Break	
Indication of	1-4
Serial Communications	
Data Format	3-1
Enabling/disabling	2-4,2-12

End of Message character	3-2
Error response	3-10
Line turn-round time	3-1
Message Types	3-2
Protocol	3-2
Scan Tables command	3-3
Start of Message character	3-2
Type 2 message	3-3
Type 3 message	3-4
Type 4 message	3-4

**Set Up Mode**

Entry into	2-1
Exit from	2-15
Lock code	2-4

**Set Up Parameters at default**

Indication of	2-2
---------------	-----

**Setpoint**

Adjustment of	1-3
---------------	-----

**Setpoint Display Strategy**

Single Setpoint operation	1-2
---------------------------	-----

**Setpoint High Limit**

2-7
-----

**Setpoint Low Limit**

2-7
-----

**Setpoint Ramp Rate**

Viewing/adjusting	1-3
-------------------	-----

**Setpoint Ramping**

Adjusting the ramping rate	1-3
Enabling/disabling	2-12

**Setpoint Strategy**

2-12	
Dual Setpoint operation	1-3

# **$\frac{1}{4}$ -DIN, $\frac{1}{8}$ -DIN & $\frac{1}{16}$ -DIN TEMPERATURE CONTROLLERS**

## **PRODUCT MANUAL**

### **VOLUME 2 INSTALLATION & CONFIGURATION INSTRUCTIONS**



The procedures described in this Volume must be undertaken only by technically-competent servicing personnel.

## Contents - Volume 2

<b>1</b>	<b>INSTALLATION</b>	<b>1-1</b>
1.1	UNPACKING	1-1
1.2	PANEL-MOUNTING	1-1
1.3	CONNECTIONS AND WIRING	1-4
<b>2</b>	<b>INTERNAL LINKS AND SWITCHES</b>	<b>2-1</b>
2.1	REMOVING THE CONTROLLER FROM ITS HOUSING	2-1
2.2	REMOVING/REPLACING THE OUTPUT 2/OUTPUT 3 OPTION PCBs	2-3
2.3	REMOVING/REPLACING THE RS485 COMMUNICATIONS OPTION PCB OR DUAL SETPOINT OPTION PCB	2-3
2.4	REPLACING THE CONTROLLER IN ITS HOUSING	2-3
2.5	SELECTION OF INPUT TYPE	2-4
2.6	SELECTION OF OUTPUT 1 TYPE	2-5
2.7	OUTPUT 2 TYPE/OUTPUT 3 TYPE	2-5
<b>3</b>	<b>CONFIGURATION MODE</b>	<b>3-1</b>
3.1	ENTRY INTO CONFIGURATION MODE	3-1
3.2	HARDWARE DEFINITION CODE	3-2
3.3	OPTION SELECTION	3-3
3.4	CONFIGURATION MODE PARAMETERS	3-4
3.5	ALARM HYSTERESIS OUTPUTS	3-8
3.6	EXIT FROM CONFIGURATION MODE	3-9
<b>APPENDIX A</b>	<b>PRODUCT SPECIFICATION</b>	<b>A-1</b>



# 1 INSTALLATION

## 1.1 UNPACKING

1. Remove the Controller from its packing. The Controller is supplied with a panel gasket and push-fit fixing strap. Retain the packing for future use, should it be necessary to transport the Controller to a different site or to return it to the supplier for repair/testing.

2. Examine the delivered items for damage or deficiencies. If any is found, notify the carrier immediately.

## 1.2 PANEL-MOUNTING

The panel on which the Controller is to be mounted must be rigid and may be up to 6.0mm (0.25 inches) thick. The cut-out required for a single Controller is as shown in Figure 1-1.

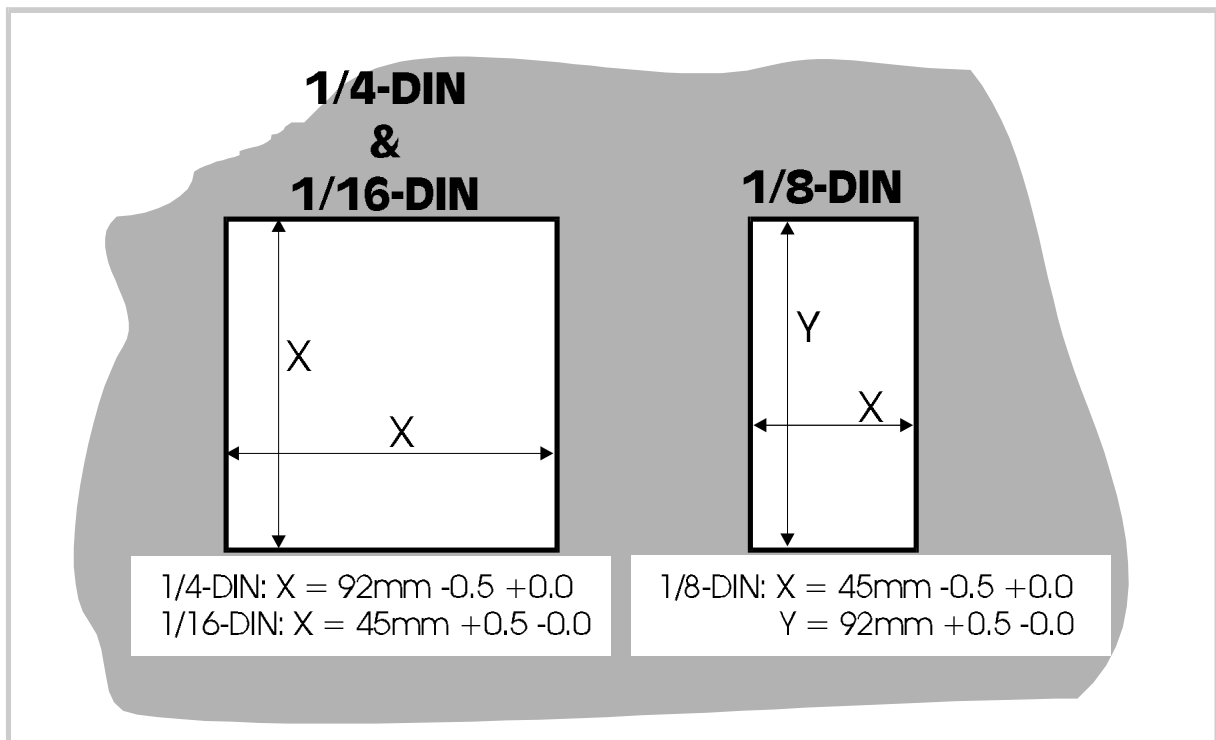

Figure 1-1 Cut-out Dimensions

Several controllers may be installed in a single cut-out, side-by-side. For n Controllers mounted side-by-side, the width of the cut-out would be:

$\frac{1}{16}$ -DIN & $\frac{1}{8}$ -DIN:	(48n - 4) millimetres or (3.78n - 0.16) inches
$\frac{1}{4}$ -DIN:	(96n - 4) millimetres or (7.56n - 0.16) inches

The main dimensions of the Controller are shown in Figure 1-2.

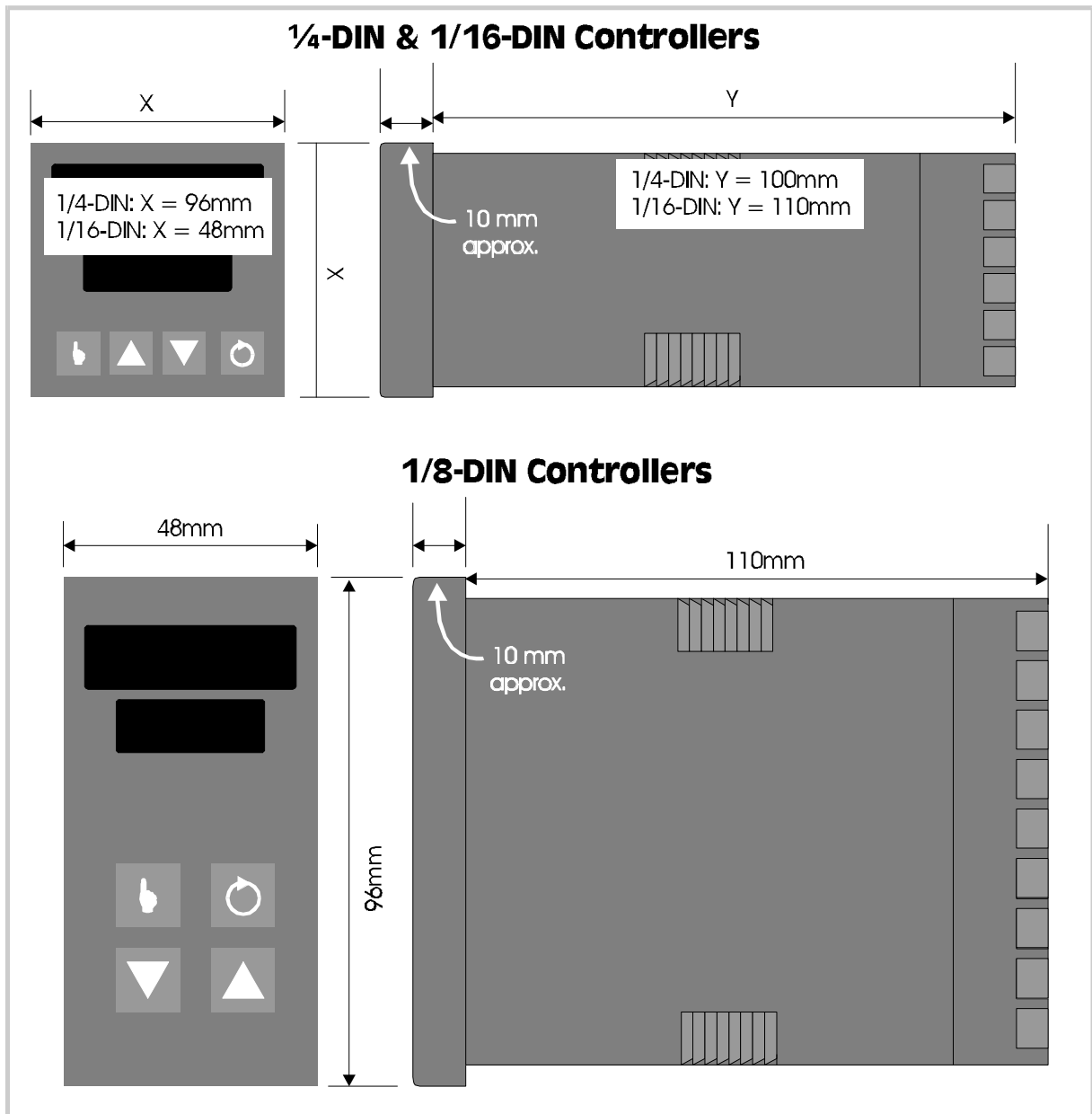

Figure 1-2 Main Dimensions

The procedure to panel-mount the Controller is shown in Figure 1-3.

**CAUTION:** Do not remove the panel gasket, as this may result in inadequate clamping of the instrument in the panel.

**NOTE:** The mounting clamp tongues may engage the ratchets either on the sides of the Controller housing or on the top/bottom faces of the Controller housing. Therefore, when installing several Controllers side-by-side in one cut-out, use the ratchets on the top/bottom faces.

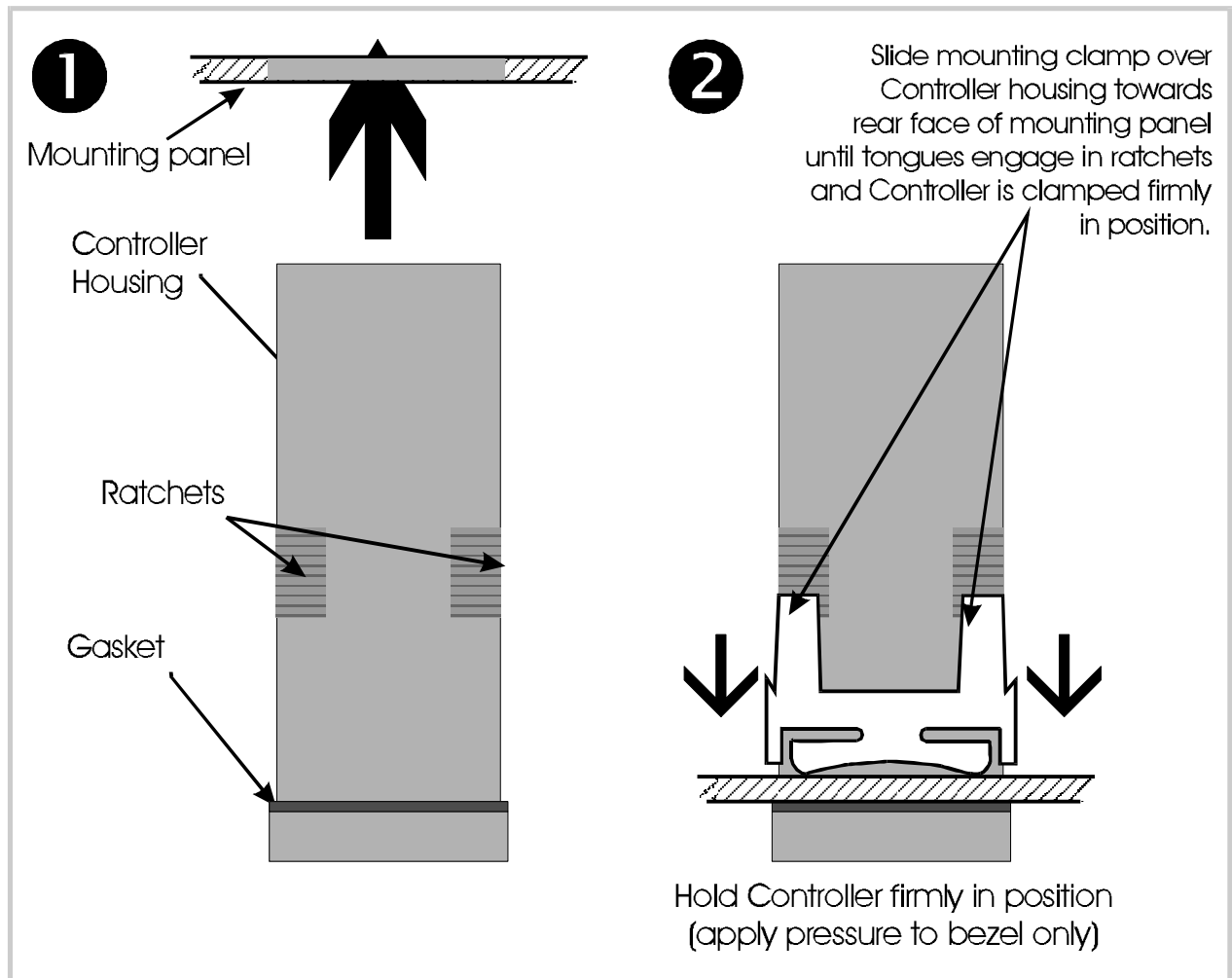

Figure 1-3 Panel-Mounting the Limit Controller

Once the Controller is installed in its mounting panel, it may be subsequently removed from its housing, if necessary, as described in Subsection 2.1.

### 1.3 CONNECTIONS AND WIRING

The rear terminal connections are illustrated in Figure 1-4 ( $\frac{1}{4}$ -DIN and  $\frac{1}{8}$ -DIN controllers) and Figure 1-5 ( $\frac{1}{16}$ -DIN controllers).

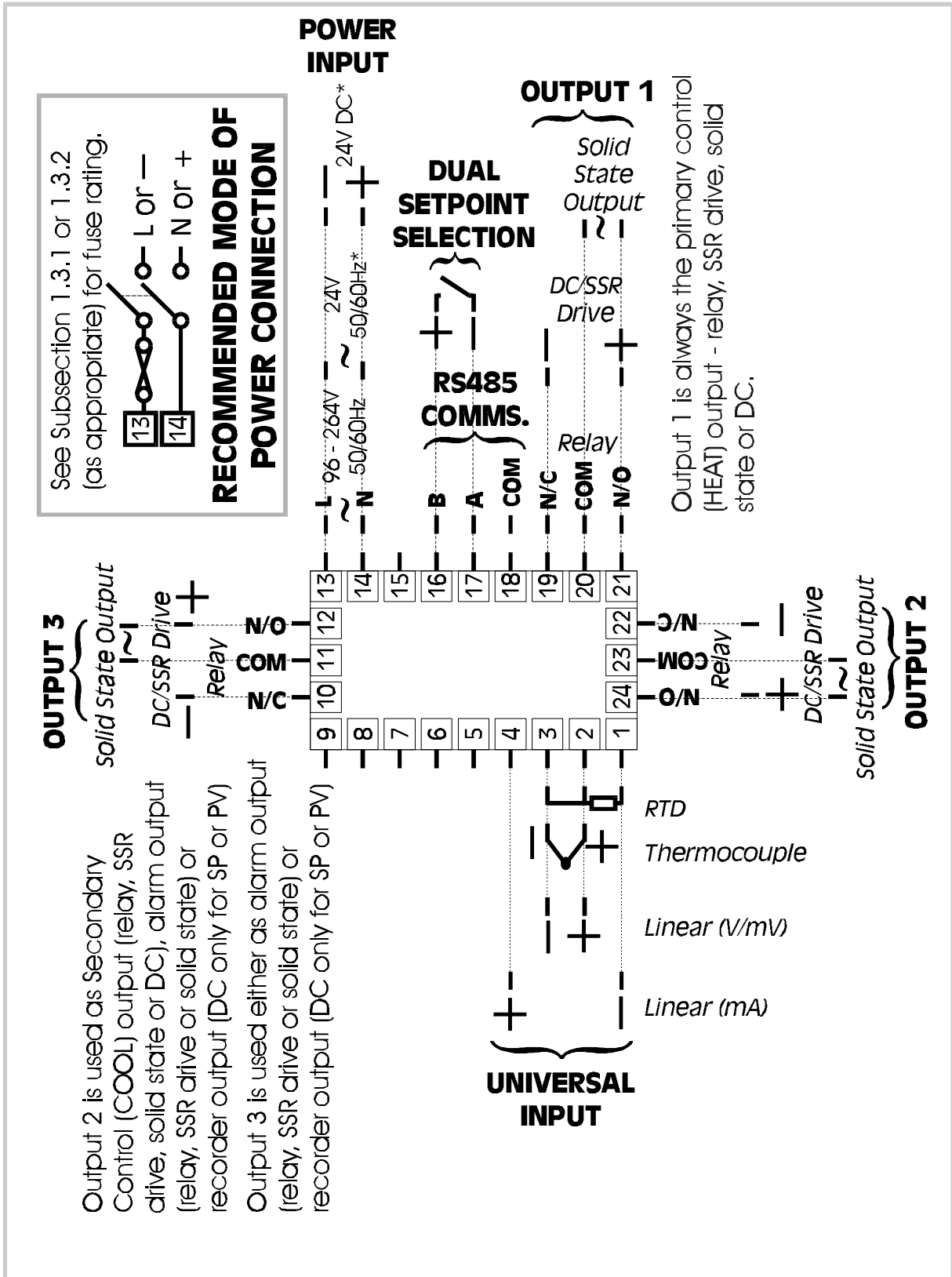

Figure 1-4 Rear Terminals ( $\frac{1}{4}$ -DIN &  $\frac{1}{8}$ -DIN Controllers)

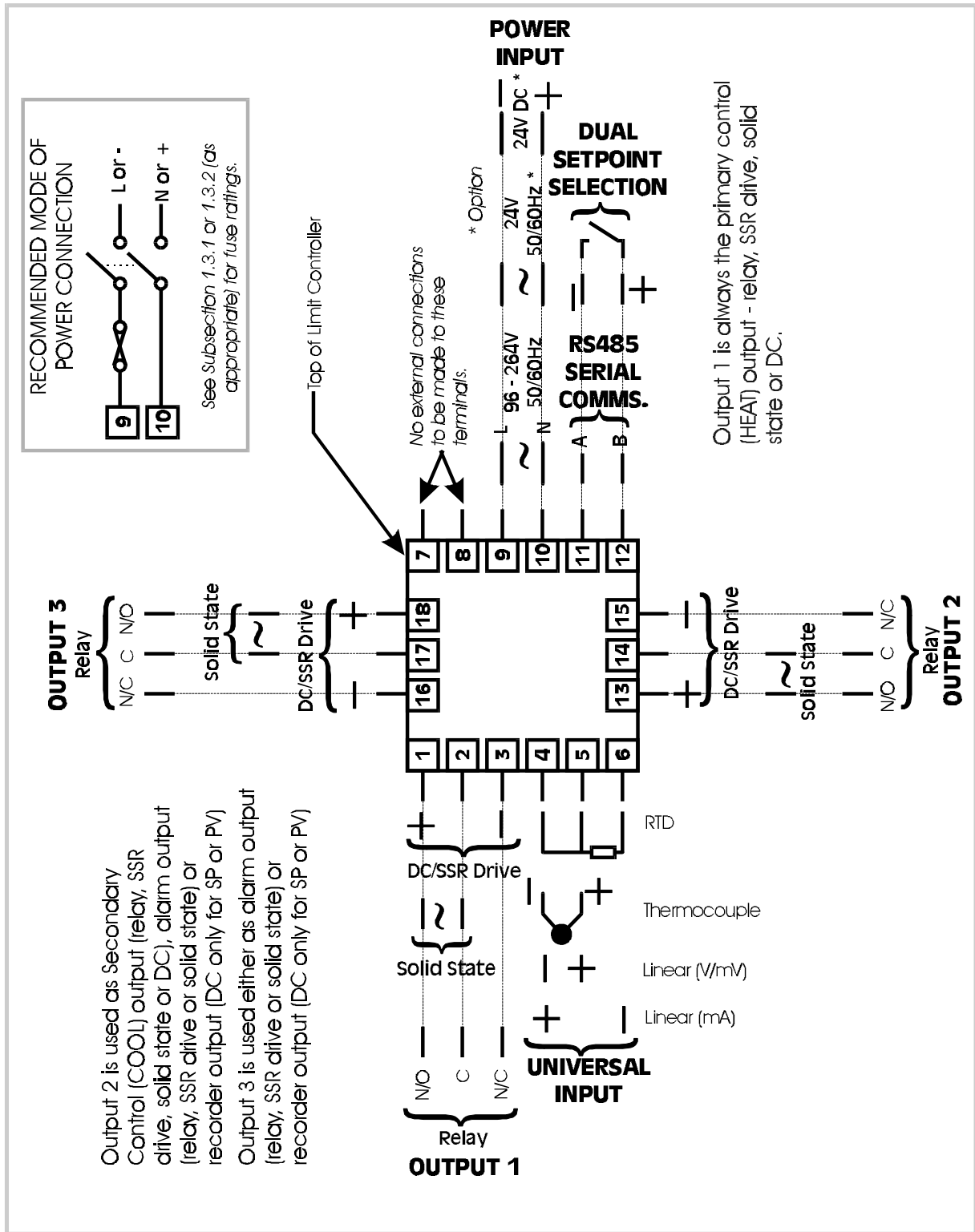

Figure 1-5 Rear Terminals ( $\frac{1}{16}$ -DIN Controllers)

### 1.3.1 Mains (Line) Input

The Controller will operate on 96 - 264V AC 50/60Hz mains (line) supply. The power consumption is approximately 4 VA.

**CAUTION:** This equipment is designed for installation in an enclosure which provides adequate protection against electric shock. Local regulations regarding electrical installation should be rigidly observed. Consideration should be given to prevention of access to the power terminations by unauthorised personnel. Power should be connected via a two-pole isolating switch (preferably situated near the equipment) and a 1A fuse, as shown in Figures 1-4 and 1-5.

If the Controller has relay outputs in which the contacts are to carry mains (line) voltage, it is recommended that the relay contact mains (line) supply should be switched and fused in a similar manner but should be separate from the Controller mains (line) supply.

### 1.3.2 24V (Nominal) AC/DC Supply

The supply connections for the 24V AC/DC option of the Controller are as shown in Figures 1-4 and 1-5. Power should be connected via a two-pole isolating switch and a 315mA slow-blow (anti-surge Type T) fuse. With the 24V AC/DC supply option fitted, these terminals will accept the following supply voltage ranges:

24V (nominal) AC 50/60Hz -	20 - 50V
24V (nominal) DC -	22 - 65V

### 1.3.3 Thermocouple Input

The correct type of thermocouple extension leadwire or compensating cable must be used for the entire distance between the Controller and the thermocouple, ensuring that the correct polarity is observed throughout. Joints in the cable should be avoided, if possible. The Controller's CJC facility must be enabled (normal conditions) for this input (see Subsection 3.4).

**NOTE:** Do not run thermocouple cables adjacent to power-carrying conductors. If the wiring is run in a conduit, use a separate conduit for the thermocouple wiring. If the thermocouple is grounded, this must be done at one point only. If the thermocouple extension lead is shielded, the shield must be grounded at one point only.

### 1.3.4 RTD Inputs

The compensating lead should be connected to Terminal 4 ( $\frac{1}{16}$ -DIN controllers) or Terminal 3 ( $\frac{1}{4}$ -DIN and  $\frac{1}{8}$ -DIN controllers). For two-wire RTD inputs, Terminals 4 & 5 ( $\frac{1}{16}$ -DIN controllers) or Terminals 2 and 3 ( $\frac{1}{4}$ -DIN and  $\frac{1}{8}$ -DIN controllers) should be linked. The extension leads should be of copper and the resistance of the wires

connecting the resistance element should not exceed 5 ohms per lead (the leads should be of equal length).

### 1.3.5 Linear Inputs

For linear mA input ranges, connection is made to Terminals 4 and 6 ( $\frac{1}{16}$ -DIN controllers) or Terminals 4 and 1 ( $\frac{1}{4}$ -DIN &  $\frac{1}{8}$ -DIN controllers) in the polarity shown in Figures 1-4 and 1-5. For linear mV and V ranges, connection is made to Terminals 4 and 5 ( $\frac{1}{16}$ -DIN controllers) or Terminals 3 and 2 ( $\frac{1}{4}$ -DIN &  $\frac{1}{8}$ -DIN controllers) in the polarity shown in Figures 1-4 and 1-5. For details of the linear input ranges available, refer to Appendix A.

### 1.3.6 Dual Setpoint Selection Input

With the Dual Setpoint option fitted, Terminals 11 and 12 ( $\frac{1}{16}$ -DIN controllers) or Terminals 16 and 17 ( $\frac{1}{4}$ -DIN &  $\frac{1}{8}$ -DIN controllers) are used for external selection of the active setpoint. These terminals may be connected to (a) the voltage-free contacts of a switch or relay, or (b) a TTL-compatible voltage. Setpoint selection is as follows:

Voltage-Free:           Contacts open - Setpoint 1 selected  
                                  Contacts closed - Setpoint 2 selected

TTL-compatible:       >2.0V - Setpoint 1 selected  
                                  <0.8V - Setpoint 2 selected

NOTE: The Dual Setpoint option and the RS485 Serial Communications option are mutually exclusive.

### 1.3.7 Relay Outputs

The contacts are rated at 2A resistive at 120/240V AC.

### 1.3.8 SSR Drive Outputs

These outputs produce a time-proportioned non-isolated DC signal (0 - 4.2V nominal into 1k $\Omega$  minimum).

### 1.3.9 Solid State Outputs

These outputs provide up to 1A AC drive with a longer lifetime than an electromechanical relay. For further details, refer to Appendix A.

### 1.3.10 DC Outputs

See Appendix A.

### **1.3.11 RS485 Serial Communications Link**

The cable used should be suitable for data transfer at the selected rate (1200, 2400, 4800 or 9600 Baud) over the required distance. Transmitters/receivers conform to the recommendations in the EIA Standard RS485.

The A terminal on the Controller should be connected to the A terminal on the master device; the B terminal on the Controller should be connected to the B terminal on the master device. Where several Controllers are connected to one master port, the master port transceiver in the active state should be capable of driving a load of 12k $\Omega$  per Controller; the master port transceiver in the passive state must have pull-up/pull-down resistors of sufficiently low impedance to ensure that it remains in the quiescent state whilst supplying up to  $\pm 100\mu\text{A}$  each to the Controller transceivers in the high impedance state.

NOTE: The RS485 Serial Communications option and the Dual Setpoint option are mutually exclusive.



## 2 INTERNAL LINKS AND SWITCHES

NOTE: The operations described in this Section should be performed only by personnel trained and authorised to do so.

### 2.1 REMOVING THE CONTROLLER FROM ITS HOUSING

**CAUTION:** Before removing the Controller from its housing, ensure that all power has been removed from the rear terminals.

To withdraw the Controller from its housing, simply grip the side edges of the front panel (there is a finger grip on each edge) and pull the Controller forwards. This will release the Controller from its rear connectors in the housing and will give access to the Controller PCBs. Take note of the orientation of the Controller for subsequent replacement into the housing. The positions of the PCBs in the Controller are shown in Figure 2-1.

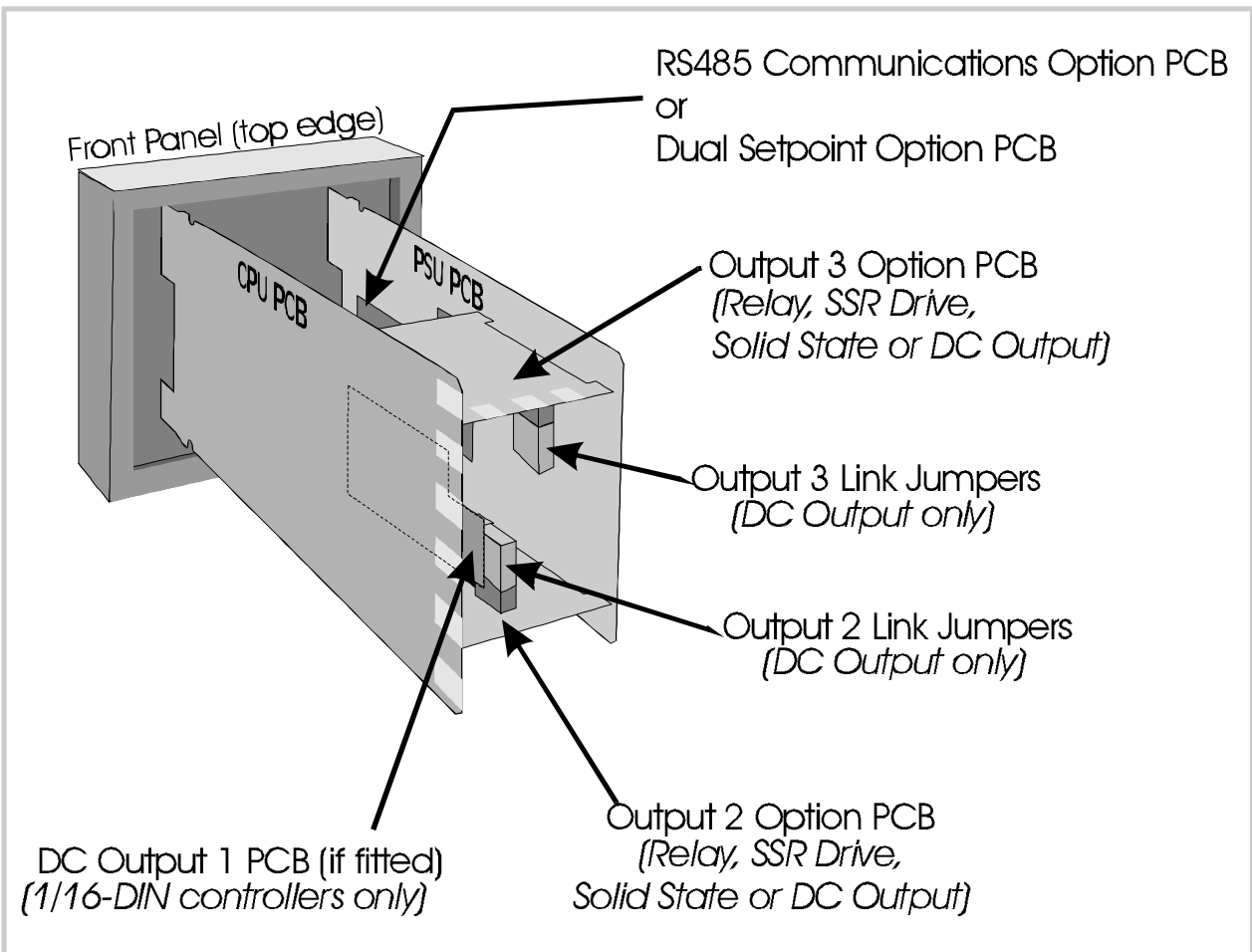

Figure 2-1 PCB Positions

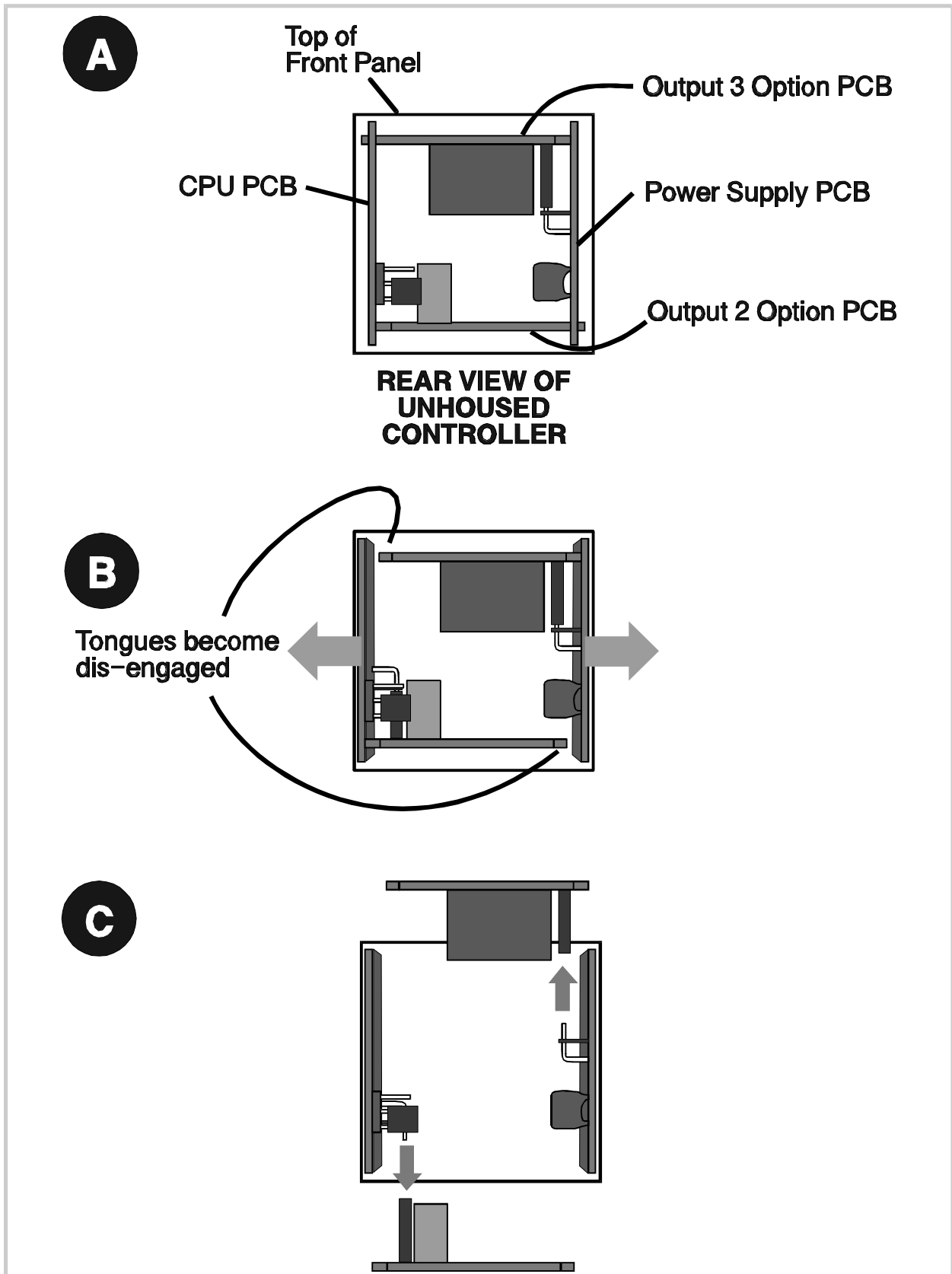

Figure 2-2 Removing the Output 2/Output 3 Option PCBs

## **2.2 REMOVING/REPLACING THE OUTPUT 2/OUTPUT 3 OPTION PCBs**

With the Controller removed from its housing:

1. Gently push the rear ends of the CPU PCB and Power Supply PCB apart slightly, until the two tongues on each of the Output 2/Output 3 Option PCBs become dis-engaged - see Figure 2-2B; The Output 2 Option PCB tongues engage in holes in the Power Supply PCB and the Output 3 Option PCB tongues engage in holes on the CPU PCB.
2. Carefully pull the required Option PCB (Output 2 or Output 3) from its connector (Output 2 Option PCB is connected to the CPU PCB and Output 3 Option PCB is connected to the Power Supply PCB) - see Figure 2-2C. Note the orientation of the PCB in preparation for its replacement.

Adjustments may now be made to the link jumpers on the CPU PCB, the Output 2/Output 3 Option PCBs (if DC output) and (on  $\frac{1}{16}$ -DIN Controllers, if fitted) the DC Output 1 PCB. The replacement procedure is a simple reversal of the removal procedure.

## **2.3 REMOVING/REPLACING THE RS485 COMMUNICATIONS OPTION PCB OR DUAL SETPOINT OPTION PCB**

This Option PCB is mounted on the inner surface of the Power Supply PCB and can be removed when the Controller is removed from its housing (see Subsection 2.1) Figure 2-3 illustrates the removal/replacement procedure. *It is not necessary to remove the Output 2/Output 3 Option PCBs to perform this procedure.*

## **2.4 REPLACING THE CONTROLLER IN ITS HOUSING**

To replace the Controller, simply align the CPU PCB and Power Supply PCB with their guides and connectors in the housing and slowly but firmly push the Controller into position.

**CAUTION:** Ensure that the instrument is correctly orientated. A stop will operate if an attempt is made to insert the instrument in the wrong orientation (e.g. upside-down). *This stop must not be over-ridden.*

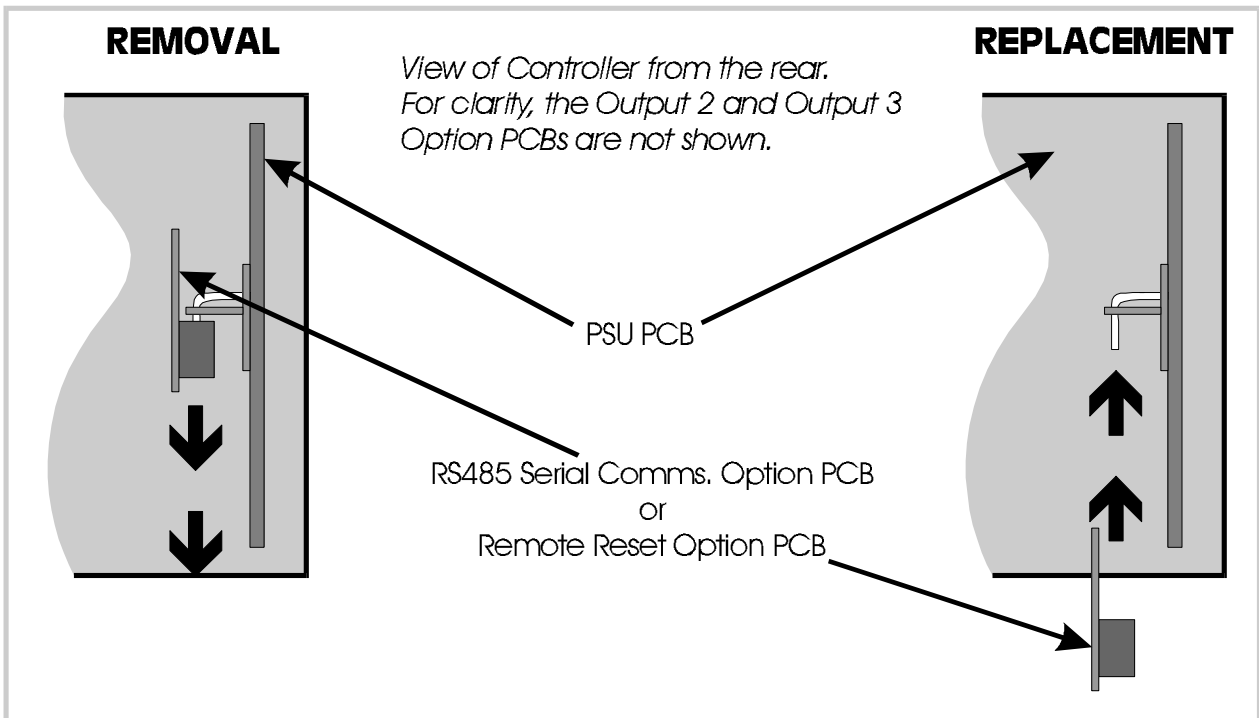

Figure 2-3 Removing the RS485 Communications Option PCB or the Dual Setpoint Option PCB

## 2.5 SELECTION OF INPUT TYPE

### 2.5.1 1/16-DIN Controllers

The selection of input type is accomplished on link jumpers on the CPU PCB. The CPU PCB may be either of two forms: (a) for a relay or SSR Output 1 (see Figure 2-4) or for a DC Output 1 (see Figure 2-5). Input type selection is as shown on the right.

Input Type	Link Jumpers Fitted
RTD or DC (mV)	None (Parked)
Thermocouple	LJ3
DC (mA)	LJ2
DC (V)	LJ1

### 2.5.2 1/4-DIN and 1/8-DIN Controllers

The selection of input type is accomplished on link jumpers on the CPU PCB (see Figure 2-6). Input type selection is as shown on the right.

Input Type	Link Jumpers Fitted
RTD or DC (mV)	None (Parked)
Thermocouple	LJ3
DC (mA)	LJ2
DC (V)	LJ1

## 2.6 SELECTION OF OUTPUT 1 TYPE

### 2.6.1 $\frac{1}{16}$ -DIN Controllers

The required type of Output 1 is selected by Link Jumpers LJ4, LJ5, LJ6 and LJ7 on the Relay/SSR Output 1 CPU PCB (see Figure 2-4) or, on the DC Output 1 CPU PCB, Link Jumpers LJ8 and LJ9 (see Figure 2-5). Output type selection is as shown on the right.

Output 1 Type	Link Jumpers Fitted
Relay or Solid State	LJ5 & LJ6
SSR Drive	LJ4 & LJ7
DC (0 - 10V)	LJ8
DC (0 - 20mA)	LJ9
DC (0 - 5V)	LJ8
DC (4 - 20mA)	LJ9

### 2.6.2 $\frac{1}{4}$ -DIN and $\frac{1}{8}$ -DIN Controllers

The required type of Output 1 is selected by Link Jumpers LJ4, LJ5, LJ6, LJ7, LJ8 and LJ9 on the PSU PCB (see Figure 2-7). Output type selection is as shown on the right.

Output 1 Type	Link Jumpers Fitted
Relay or Solid State	LJ5 & LJ6
SSR Drive	LJ4 & LJ7
DC (0 - 10V)	LJ8
DC (0 - 20mA)	LJ9
DC (0 - 5V)	LJ8
DC (4 - 20mA)	LJ9

## 2.7 OUTPUT 2 TYPE/OUTPUT 3 TYPE

The type of output for Output 2 and Output 3 is determined by the Option PCB fitted in the appropriate position (see Figure 2-1). There are four types of option PCB which may be used for Output 2 and Output 3:

1. Relay Output Option PCB (no link jumpers)
2. Solid State Output Option PCB (no link jumpers)
3. SSR Output Option PCB (no link jumpers)
4. DC Output Option PCB (link jumpers as shown in Figure 2-8)

In the case of the DC Output Option PCB being fitted, DC output range is selected using link jumpers LJ8 and LJ9, as shown on the right.

DC Output Range	Link Jumpers Fitted
DC (0 - 10V)	LJ8
DC (0 - 20mA)	LJ9
DC (0 - 5V)	LJ8
DC (4 - 20mA)	LJ9

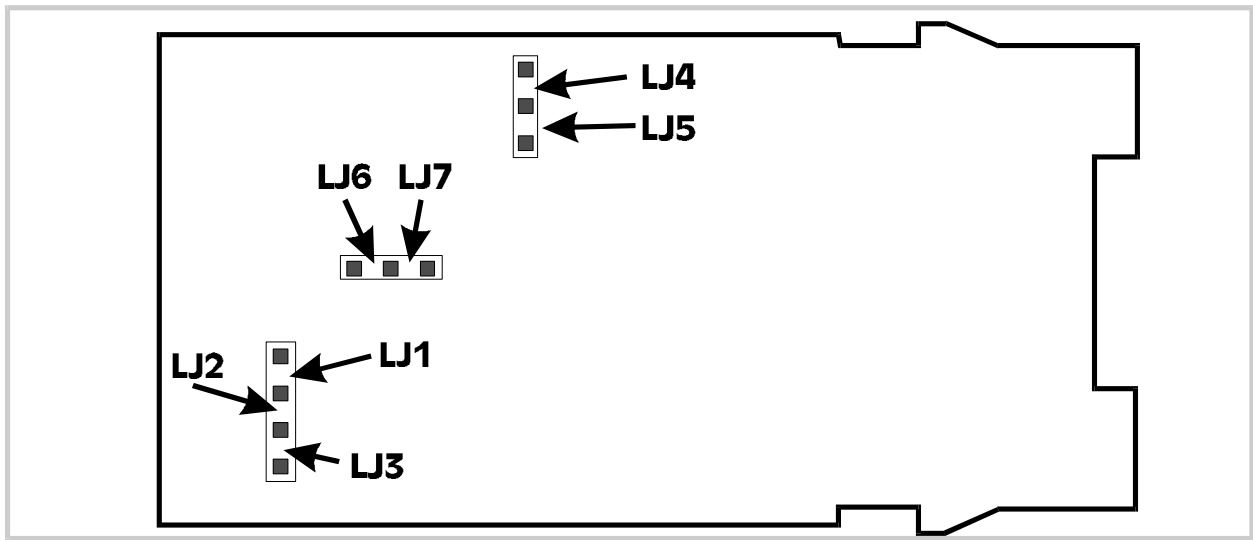

Figure 2-4 CPU PCB (Relay/SSR Drive/Solid State Output 1) -  $\frac{1}{16}$ -DIN Controllers

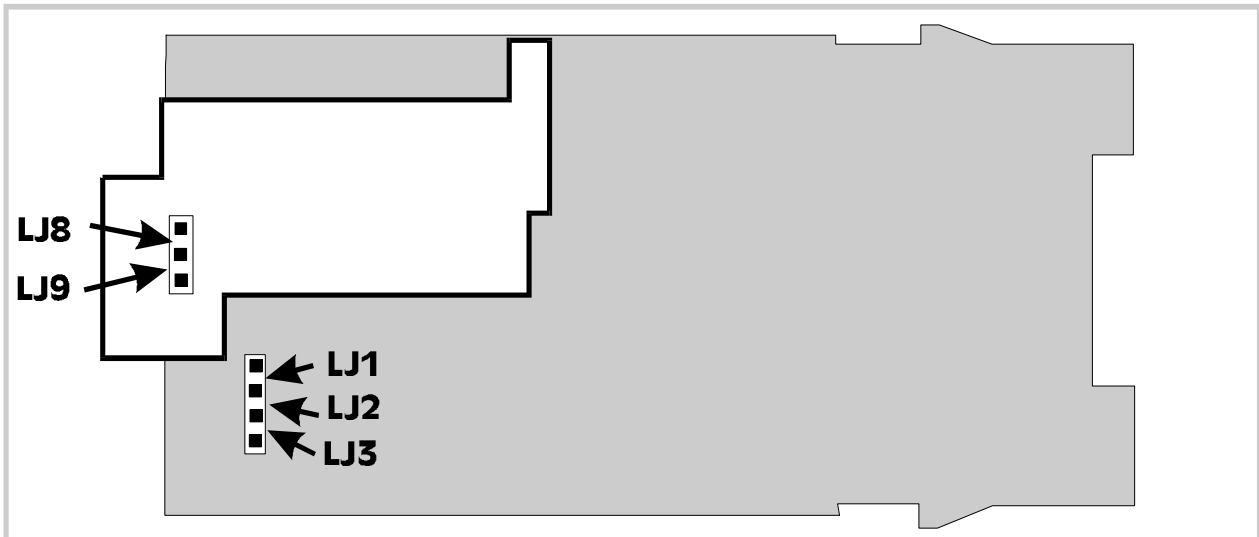

Figure 2-5 CPU PCB (DC Output 1) -  $\frac{1}{16}$ -DIN Controllers

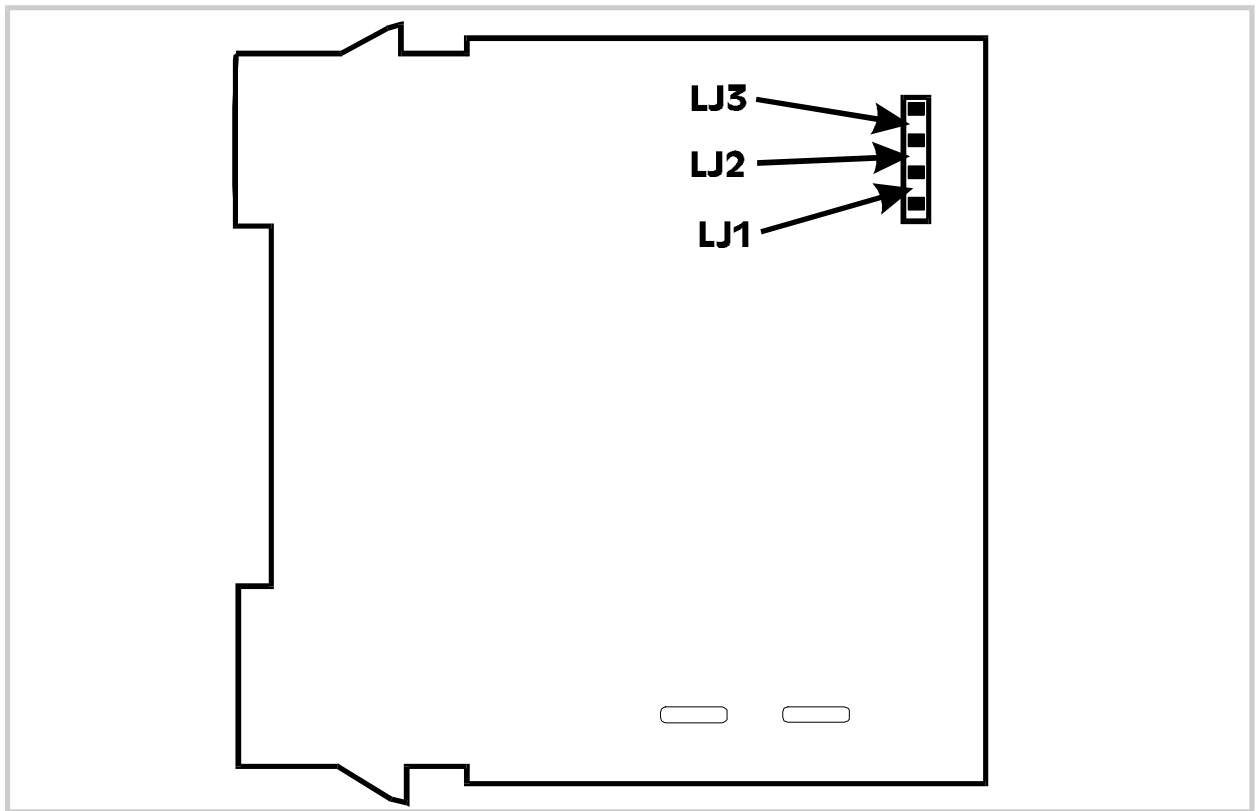

Figure 2-6 CPU PCB -  $\frac{1}{4}$ -DIN &  $\frac{1}{8}$ -DIN Controllers

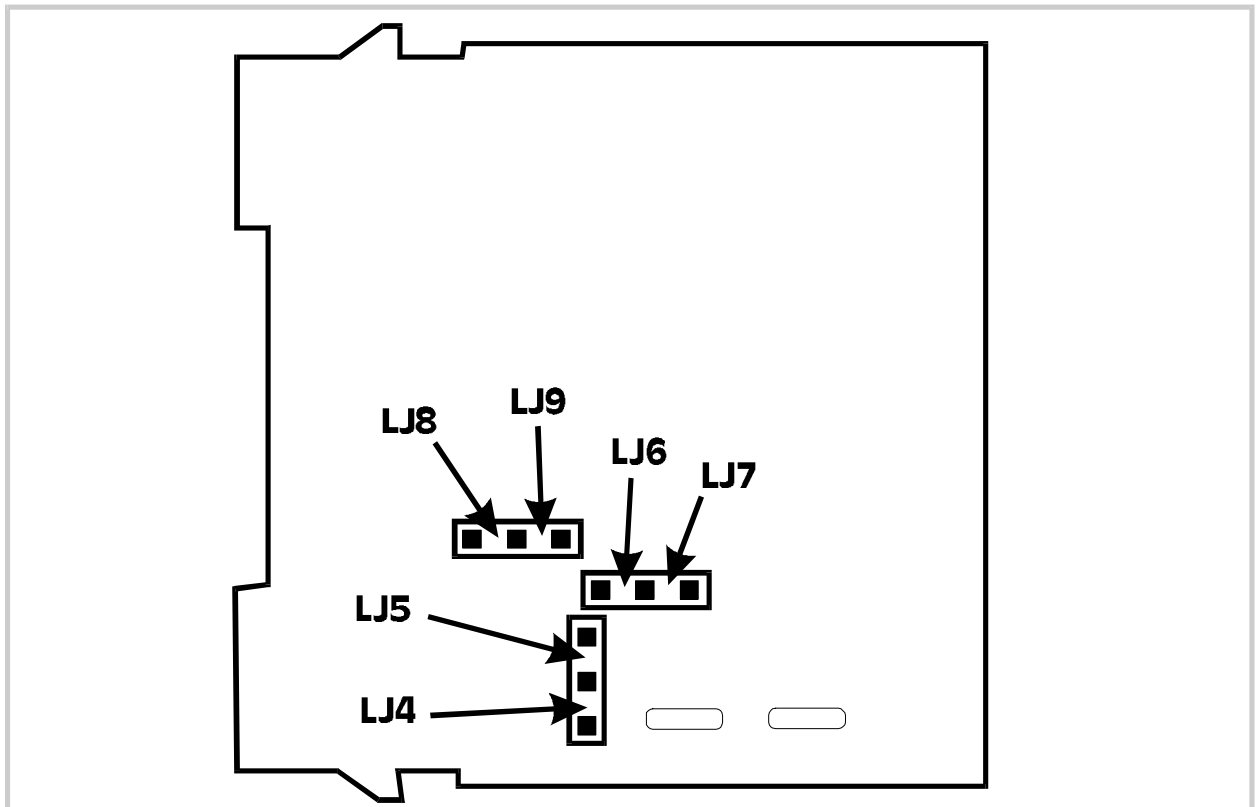

Figure 2-7 PSU PCB -  $\frac{1}{4}$ -DIN &  $\frac{1}{8}$ -DIN Controllers

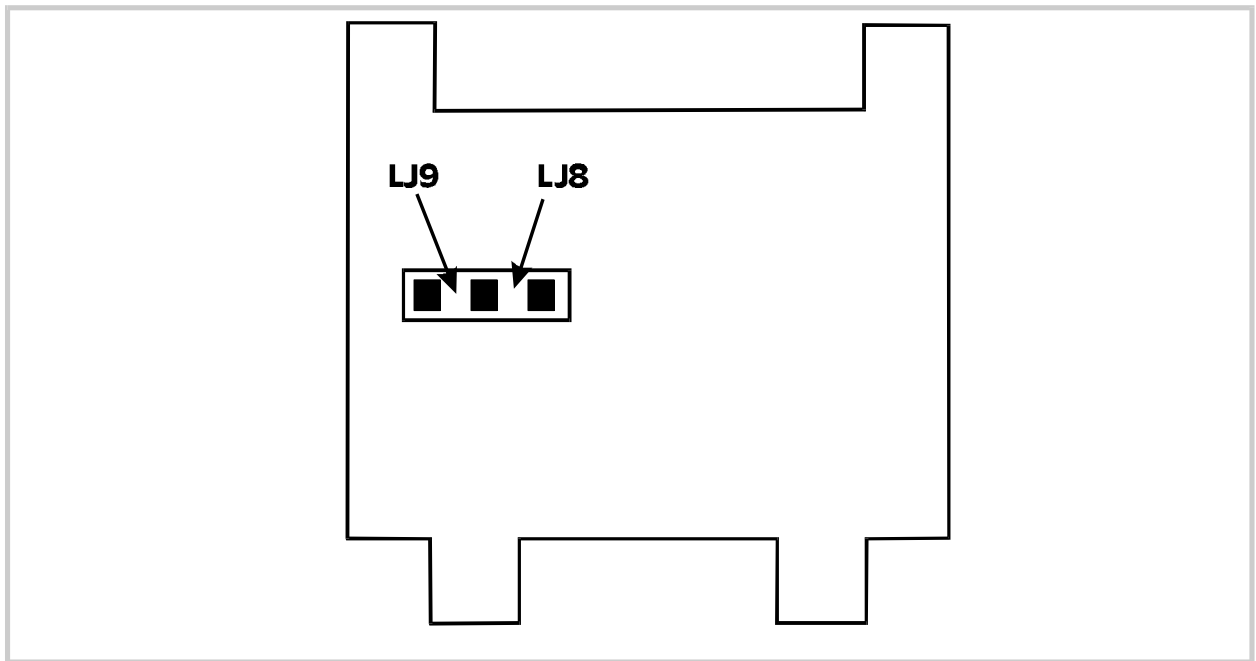

Figure 2-8 DC Output Option PCB PCB (Output 2/Output 3)



# 3 CONFIGURATION MODE

## 3.1 ENTRY INTO CONFIGURATION MODE

See Figure 3-1.

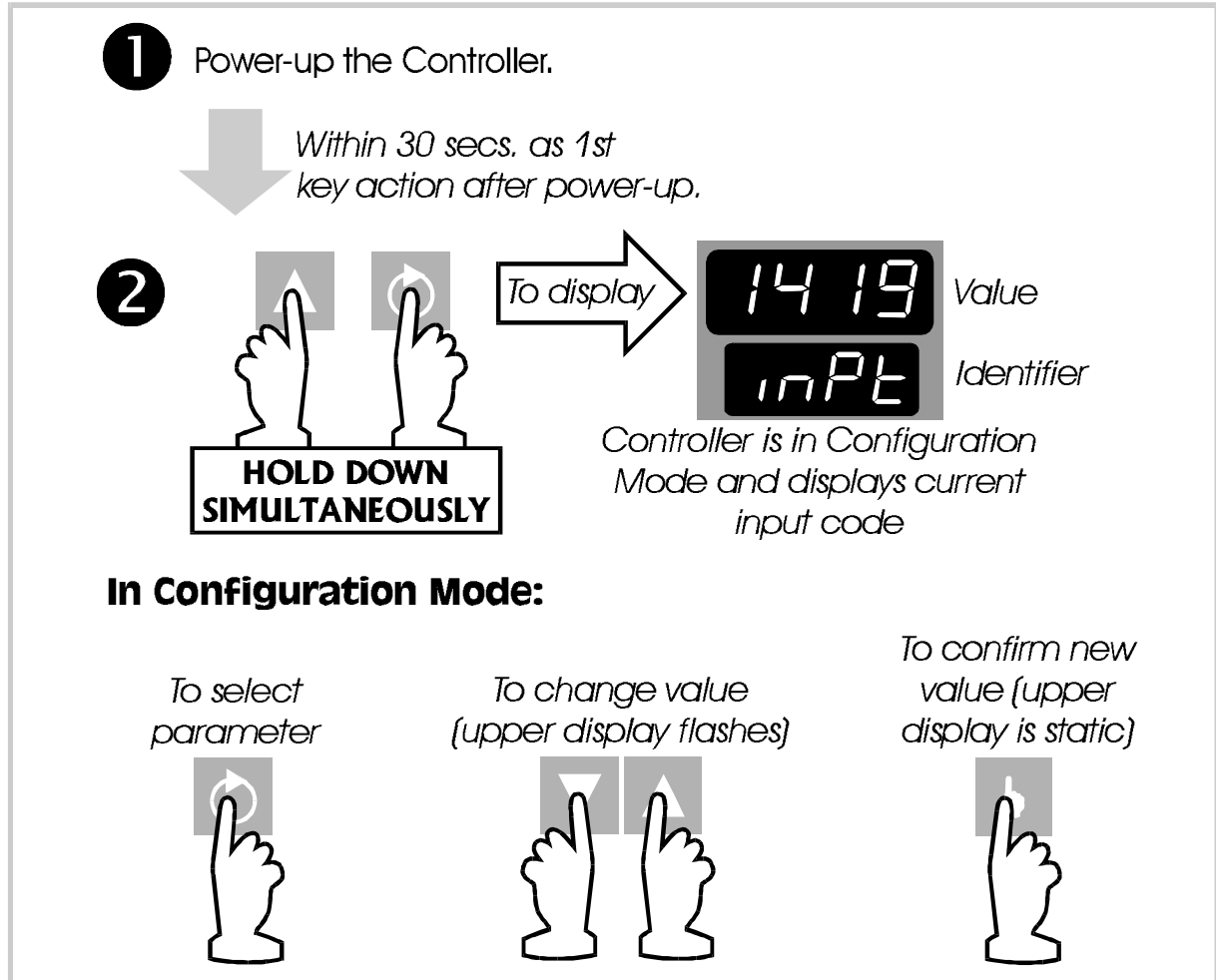

Figure 3-1 Entry into Configuration Mode

**NOTE:** Changes to the value/setting of certain Configuration Mode parameters (e.g. input range, output use and type) will cause the Set Up Mode parameters to be automatically set to their default values the next time Set Up Mode is entered (see also Volume 1, beginning of Section 2).

### 3.2 HARDWARE DEFINITION CODE

This parameter is a special facility in Configuration Mode, which is used to represent the hardware fitted (input type, Output 1 type, Output 2 type and Output 3 type); this must be compatible with the hardware actually fitted. For access to, and adjustment of, the Hardware Definition Code, see Figure 3-2.

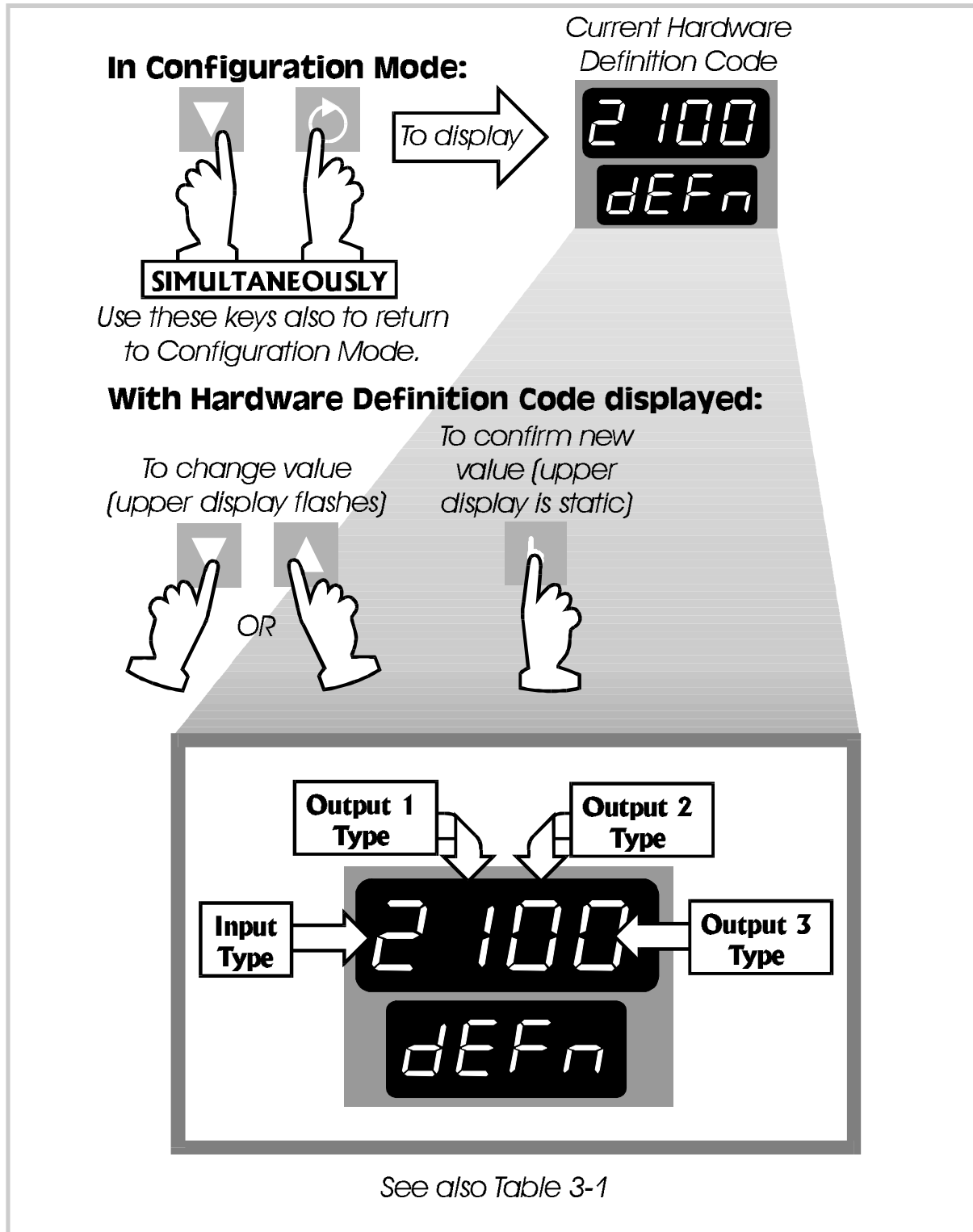

Figure 3-2 Hardware Definition Code - Access and Adjustment

Table 3-1 Hardware Definition Code - Input/Output Type Selection

Value	0	1	2	3	4	5	7	8
Input		RTD/ Linear DC mV	Thermo- couple	Linear DC mA	Linear DC V			
Output 1		Relay	SSR Drive	DC 0 - 10V	DC 0 - 20mA	DC 0 - 5V	DC 4 - 20mA	Solid State
Output 2/3	Not fitted	Relay	SSR Drive	DC 0 - 10V	DC 0 - 2-mA	DC 0 - 5V	DC 4 - 20mA	Solid State

- NOTES:
1. If Output 2 is set to be a relay/SSR drive/solid state output, it may be a control output (COOL) or an alarm output; if it is set to be a DC output, it can only be a control output (COOL).
  2. If Output 3 is set to be a relay/SSR drive/solid state output, it can only be an alarm output; if it is set to be a DC output, it can only be a recorder (i.e. re-transmitted process variable or setpoint) output.

The maximum setting available for this code is 4888. For example, the code for a thermocouple input, DC 4 - 20mA primary output (Output 1) and relay Output 3 would be 2701.

NOTE: It is essential that this code is changed promptly whenever there is a change to the Controller's hardware configuration (change of input/output type, alarm/recorder output added/removed etc.). The Controller software depends upon this code to ensure that the Controller operates correctly.

This code may be viewed as a Read Only display in Operator Mode (see Volume 1, Subsection 1.10).

### 3.3 OPTION SELECTION

This indicates the option fitted (Communications Option, Dual Setpoint Option no option at all). It is accessed whilst the Hardware Definition Code is displayed (see Figure 3-3).

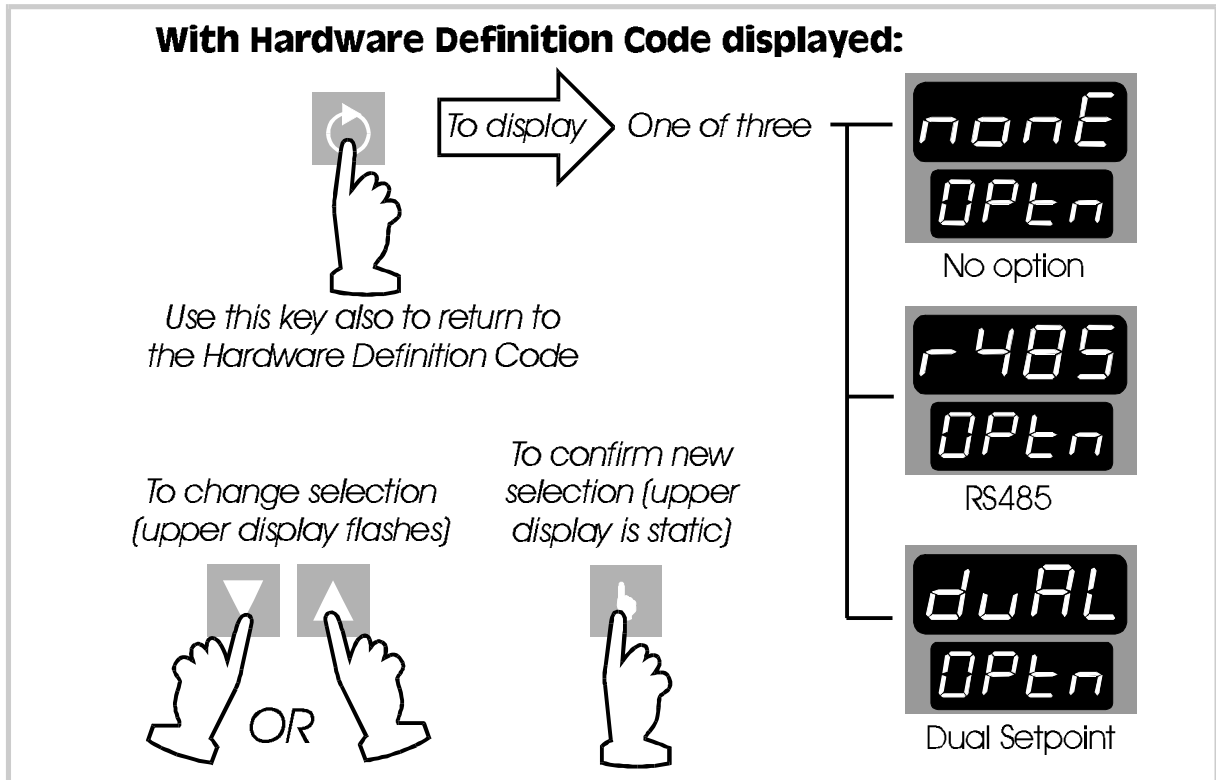

Figure 3-3 Option Selection

### 3.4 CONFIGURATION MODE PARAMETERS

Parameter	Identifier	Description
Input Range	<b>inPt</b>	A four-digit code (see Appendix A). Default settings: Thermocouple - 1419 (Type J, 0 - 761°C) RTD/Linear mV - 7220 (RTD Pt100 0 - 800°C) Linear mA - 3414 (4 - 20mA) Linear V - 4446 (0 - 10V)
Output 1 Action	<b>Ctrl</b>	<b>rEv</b> Reverse-acting <b>dir</b> Direct-acting
Alarm 1 Type	<b>ALAI</b>	<b>P_hi</b> Process High Alarm <b>P_Lo</b> Process Low Alarm <b>dE</b> Deviation Alarm <b>bAnd</b> Band Alarm <b>none</b> No alarm

Parameter	Identifier	Description
Alarm 2 Type	<b>ALAZ</b>	<b>P_h</b> Process High Alarm
		<b>P_Lo</b> Process Low Alarm (default)
		<b>dE</b> Deviation Alarm
		<b>bAnd</b> Band Alarm
		<b>nonE</b> No alarm
Alarm Inhibit	<b>Inhi</b>	<b>nonE</b> No alarms inhibited
		<b>ALA1</b> Alarm 1 inhibited
		<b>ALAZ</b> Alarm 2 inhibited
		<b>both</b> Both Alarm 1 & Alarm 2 inhibited

Parameter	Identifier	Description
Output 2 Usage	<b>USE2</b>	<b>Out2</b> Output 2 secondary control (COOL) output
		<b>A2_d</b> Alarm 2 hardware output, direct-acting. Available only if relay/SSR drive/solid state output.
		<b>A2_r</b> Alarm 2 hardware output, reverse-acting. Available only if relay, SSR drive or solid state output.
		<b>Or_d</b> Direct-acting output for Logical OR of Alarm 1 and Alarm 2. Available only if relay, SSR drive, or solid state output.
		<b>Or_r</b> Reverse-acting output for Logical OR of Alarm 1 and Alarm 2. Available only if relay, SSR drive, or solid state output.
		<b>Ad_d</b> Direct-acting output for Logical AND of Alarm 1 and Alarm 2. Available only if relay, SSR drive, or solid state output.
		<b>Ad_r</b> Reverse-acting output for Logical AND of Alarm 1 and Alarm 2. Available only if relay, SSR drive, or solid state output.
		<b>LP_d</b> Loop Alarm output, direct-acting. Available only if relay, SSR drive or solid state output.
		<b>LP_r</b> Loop Alarm output, reverse-acting. Available only if relay, SSR drive or solid state output.
		<b>HY_d</b> Alarm Hysteresis output, direct-acting. Available only if relay, SSR drive or solid state output.
<b>HY_r</b> Alarm Hysteresis output, reverse-acting. Available only if relay, SSR drive or solid state output.		

Example of Logical Combination of Alarms - Logical OR of Alarm 1 & Alarm 2

Direct-acting	Reverse-acting
AL1 OFF, AL2 OFF: Relay de-energised	AL1 OFF, AL2 OFF: Relay energised
AL1 ON, AL2 OFF: Relay energised	AL1 ON, AL2 OFF: Relay de-energised
AL1 OFF, AL2 ON: Relay energised	AL1 OFF, AL2 ON: Relay de-energised
AL1 ON, AL2 ON: Relay energised	AL1 ON, AL2 ON: Relay de-energised

Parameter	Identifier	Description
Output 3 Usage	<b>USE3</b>	<b>Al_d</b> Alarm 1 hardware output, direct-acting. Available only if relay/SSR drive/solid state output.
		<b>Al_r</b> Alarm 1 hardware output, reverse-acting. Available only if relay, SSR drive or solid state output.
		<b>Or_d</b> Direct-acting output for Logical OR of Alarm 1 and Alarm 2. Available only if relay, SSR drive, or solid state output.
		<b>Or_r</b> Reverse-acting output for Logical OR of Alarm 1 and Alarm 2. Available only if relay, SSR drive, or solid state output.
		<b>Ad_d</b> Direct-acting output for Logical AND of Alarm 1 and Alarm 2. Available only if relay, SSR drive, or solid state output.
		<b>Ad_r</b> Reverse-acting output for Logical AND of Alarm 1 and Alarm 2. Available only if relay, SSR drive, or solid state output.
		<b>LP_d</b> Loop Alarm output, direct-acting. Available only if relay, SSR drive or solid state output.
		<b>LP_r</b> Loop Alarm output, reverse-acting. Available only if relay, SSR drive or solid state output.
		<b>HY_d</b> Alarm Hysteresis output, direct-acting. Available only if relay, SSR drive or solid state output.
		<b>HY_r</b> Alarm Hysteresis output, reverse-acting. Available only if relay, SSR drive or solid state output.
		<b>rEcS</b> Recorder Output - Setpoint (DC output only)
		<b>rEcP</b> Recorder Output - Process Variable (DC Output only)

Example of Logical Combination of Alarms - Logical AND of Alarm 1 & Alarm 2

Direct-acting	Reverse-acting
AL1 OFF, AL2 OFF: Relay de-energised	AL1 OFF, AL2 OFF: Relay energised
AL1 ON, AL2 OFF: Relay de-energised	AL1 ON, AL2 OFF: Relay energised
AL1 OFF, AL2 ON: Relay de-energised	AL1 OFF, AL2 ON: Relay energised
AL1 ON, AL2 ON: Relay energised	AL1 ON, AL2 ON: Relay de-energised

Parameter	Identifier	Description
Comms. Baud Rate	<b>bAud</b>	Selectable: 1200, 2400, 4800, 9600 Baud
Comms. Address	<b>Addr</b>	Unique address assigned to the controller; in the range 1 - 32.
Cold Junction Compensation Enable/Disable*	<b>CJC</b>	<b>EnAb</b> Enabled (default) <b>dISA</b> Disabled
Lock Code	<b>Loc</b>	Read Only display of current four-digit Set Up Mode Lock Code.

\* The Cold Junction Compensation Enable/Disable parameter appears in the parameter sequence only if the input selected (see Hardware Definition Code) is Thermocouple.

### 3.5 ALARM HYSTERESIS OUTPUTS

An alarm hysteresis output is active only when both alarms are active; it becomes subsequently inactive only when both alarms become inactive. Thus, the status of the Alarm Hysteresis output when one alarm is active and the other is inactive depends upon the alarm status immediately prior to that alarm being activated; thus, with two process high alarms:

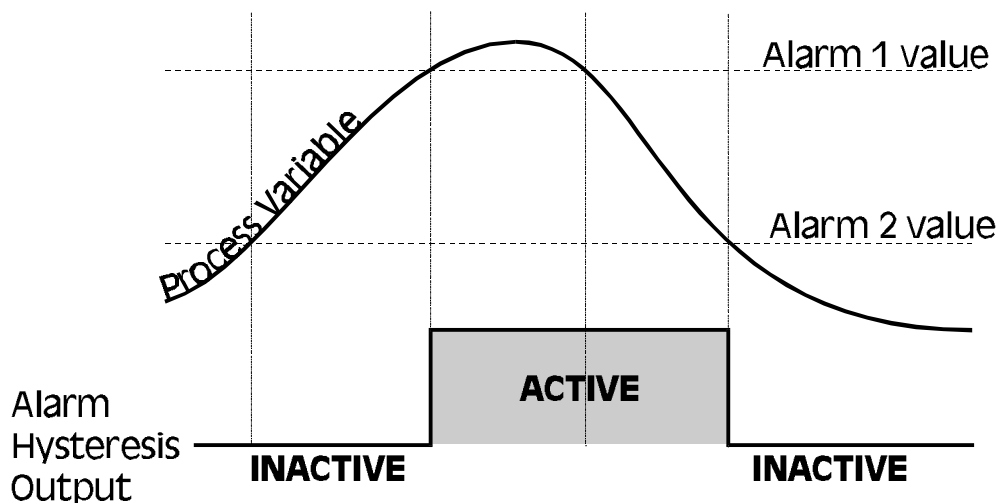



### 3.6 EXIT FROM CONFIGURATION MODE

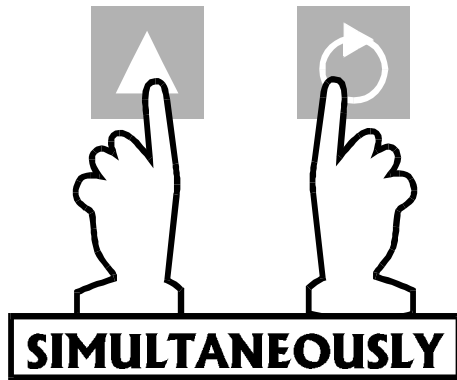

NOTE: An automatic exit to Operator Mode will be made if, in Configuration Mode, there is no front panel key activity for two minutes.

The exit is made via the power-up self-test routines which include a lamp test.

# A PRODUCT SPECIFICATION

## A.1 UNIVERSAL INPUT

### General

Maximum per Controller:	One
Input Sample Rate:	Four samples/second
Digital Input Filter:	Time constant selectable from front panel - 0.0 (i.e. OFF), 0.5 to 100.0 seconds in 0.5-second increments.
Input Resolution:	14 bits approximately; always four times better than display resolution.
Input Impedance:	Greater than 100MΩ resistive (except for DC mA and V inputs).
Isolation:	Universal input isolated from all outputs except SSR at 240V AC.
Process Variable Offset:	Adjustable ±input span.

**Thermocouple:** Ranges selectable from front panel (with displayed codes):

Type	Input Range	Displayed Code	Type	Input Range	Displayed Code
R	0 - 1650°C	1127	J	32 - 1401°F	1420
R	32 - 3002°F	1128	T	-200 - 262°C	1525
S	0 - 1649°C	1227	T	-328 - 503°F	1526
S	32 - 3000°F	1228	T	0.0 - 260.6°C	1541
J	0.0 - 205.4°C	1415	T	32.0 - 501.0°F	1542
J	32.0 - 401.7°F	1416	K	-200 - 760°C	6726
J	0 - 450°C	1417	K	-328 - 1399°F	6727
J	32 - 842°F	1418	K	-200 - 1373°C	6709
J	0 - 761°C *	1419	K	-328 - 2503°F	6710

\* Default

*Continued overleaf.....*

Type	Input Range	Displayed Code	Type	Input Range	Displayed Code
L	0.0 - 205.7°C	1815	L	32 - 1403°F	1820
L	32.0 - 402.2°F	1816	B	211 - 3315°F	1934
L	0 - 450°C	1817	B	100 - 1824°C	1938
L	32 - 841°F	1818	N	0 - 1399°C	5371
L	0 - 762°C	1819	N	32 - 2550°F	5324

Calibration: Complies with BS4937, NBS125 and IEC584.

Sensor Break Protection: Break detected within two seconds. Control outputs set to OFF (0% power); Alarms operate as if the process variable has gone over-range.

**Resistance Temperature Detector (RTD) and DC mV:** Ranges selectable from front panel (with displayed codes):

Input Range	Displayed Code	Input Range	Displayed Code
0 - 800°C *	7220	0.0 - 100.9°C	2295
32 - 1471°F	7221	32.0 - 213.6°F	2296
32 - 571°F	2229	-200 - 206°C	2297
-100.9 - 100.0°C	2230	-328 - 402°F	2298
-149.7 - 211.9°F	2231	-100.9 - 537.3°C	7222
0 - 300°C	2251	-149.7 - 999.1°F	7223

\* Default

Type and Connection: Three-wire Pt100

Calibration: Complies with BS1904 and DIN43760.

Lead Compensation: Automatic scheme.

RTD Sensor Current: 150 $\mu$ A (approximately)

Sensor Break Protection: Break detected within two seconds. Control outputs set to OFF (0% power). Alarm operation is as follows:

Input Type	Location of Break		Alarm Operation
	$\frac{1}{4}$ -DIN or $\frac{1}{8}$ -DIN Controller	$\frac{1}{16}$ -DIN Controller	
RTD	Sensor or Terminal 1	Sensor or Terminal 6	As if Process Variable is over-range
RTD	Terminal 3 or 2	Terminal 4 or 5	As if Process Variable is under-range
DC (mV)	-	-	As if Process Variable is over-range

**DC Linear:** Ranges Selectable from Front Panel (with displayed codes):

Input Range	Displayed Code	Input Range	Displayed Code
0 - 20mA	3413	0 - 5V	4445
4 - 20mA *	3414	1 - 5V	4434
0 - 50mV	4443	0 - 10V *	4446
10 - 50mV	4499	2 - 10V	4450

\* Default

(Changes may also be required to the CPU PCB link jumpers - see Subsection 2.5.)

Scale Range Maximum: 1999 to 9999. Decimal point as required.

Scale Range Minimum: 1999 to 9999. Decimal point as for Scale Range Maximum.

Minimum Span: 1 display LSD.

Sensor Break Protection: Applicable to 4 - 20mA, 1 - 5V and 2 - 10V ranges only. Break detected within two seconds. Control outputs set to OFF (0% power); Alarms operate as if the process variable has gone under-range.

## A.2 DUAL SETPOINT SELECTION INPUT (OPTION)

Type: Voltage-free or TTL-compatible

Voltage-Free Operation: Connection to contacts of external switch or relay; contacts open = Setpoint 1 selected (minimum contact resistance = 5000 $\Omega$ ), contacts closed = Setpoint 2 selected (maximum contact resistance = 50 $\Omega$ ).

TTL levels: To select Setpoint 1: 0.6V to 0.8V  
To select Setpoint 2: 2.0V to 24V

Maximum Input Delay  
(OFF-ON): 1 second

Minimum Input Delay  
(ON-OFF): 1 second

### A.3 OUTPUT 1

#### General

Types Available: Relay (as standard), SSR drive, solid state and DC as options.

#### Relay

Contact Type: Single pole double throw (SPDT).

Rating: 2A resistive at 120/240V AC.

Lifetime: >500,000 operations at rated voltage/current.

Isolation: Inherent.

#### SSR Drive/TTL

Drive Capability: SSR >4.2V DC into 1k $\Omega$  min. ( $\frac{1}{16}$ -DIN)  
SSR > 4.3V into 250 $\Omega$  min. ( $\frac{1}{4}$ -DIN &  $\frac{1}{8}$ -DIN)

Isolation: Not isolated from input or other SSR drive outputs.

#### Solid State

Operating Voltage Range: 20 - 280Vrms (47 - 63Hz)

Current Rating: 0.01 - 1A (full cycle rms on-state @ 25°C);  
derates linearly above 40°C to 0.5A @ 80°C.

Max. Non-repetitive Surge Current (16.6ms): 25A peak

Min. OFF-State  $\frac{dv}{dt}$  @ Rated Voltage: 500V/ $\mu$ s

Max. OFF-State leakage @ Rated Voltage: 1mA rms

Max. ON-State Voltage Drop @ Rated Current:	1.5V peak.
Repetitive Peak OFF-state Voltage, $V_{drm}$ :	600V minimum.

**DC**

Resolution:	Eight bits in 250mS (10 bits in 1 second typical, >10 bits in >1 second typical).
Update Rate:	Every control algorithm execution.
Ranges:	0 - 20mA 4 - 20mA 0 - 10V 0 - 5V

(Changes between V and mA ranges also require link jumper movement.)

Load Impedance:	0 - 20mA: 500 $\Omega$ maximum 4 - 20mA: 500 $\Omega$ maximum 0 - 10V: 500 $\Omega$ minimum 0 - 5V: 500 $\Omega$ minimum
Isolation:	Isolated from all other inputs and outputs.
Range Selection Method:	Link jumper or DIP switch and front panel code.

**A.4 OUTPUT 2****General**

Types Available:	Relay, SSR drive, solid state and DC.
------------------	---------------------------------------

**Relay**

Contact Type:	Single pole double throw (SPDT).
Rating:	2A resistive at 120/240V AC.
Lifetime:	>500,000 operations at rated voltage/current.
Isolation:	Inherent.

**SSR Drive/TTL**

Drive Capability:	SSR > 4.2V DC into 1k $\Omega$ min. ( $\frac{1}{16}$ -DIN) SSR > 4.3V into 250 $\Omega$ min. ( $\frac{1}{4}$ -DIN & $\frac{1}{8}$ -DIN)
Isolation:	Not isolated from input or other SSR drive outputs.

**Solid State**

Operating Voltage Range:	20 - 280Vrms (47 - 63Hz)
Current Rating:	0.01 - 1A (full cycle rms on-state @ 25°C); derates linearly above 40°C to 0.5A @ 80°C.
Max. Non-repetitive Surge Current (16.6ms):	25A peak
Min. OFF-State $\frac{dv}{dt}$ @ Rated Voltage:	500V/ $\mu$ s
Max. OFF-State leakage @ Rated Voltage:	1mA rms
Max. ON-State Voltage Drop @ Rated Current:	1.5V peak.
Repetitive Peak OFF-state Voltage, V <sub>drm</sub> :	600V minimum.

**DC**

Resolution:	Eight bits in 250mS (10 bits in 1 second typical, > 10 bits in > 1 second typical).
Update Rate:	Every control algorithm execution.
Ranges:	0 - 20mA 4 - 20mA 0 - 10V 0 - 5V

(Changes between V and mA ranges also require link jumper movement.)

Load Impedance:	0 - 20mA: 500 $\Omega$ maximum 4 - 20mA: 500 $\Omega$ maximum 0 - 10V: 500 $\Omega$ minimum 0 - 5V: 500 $\Omega$ minimum
-----------------	---

Isolation:	Isolated from all other inputs and outputs.
Range Selection Method:	Link jumper or DIP switch and front panel code.

## A.5 OUTPUT 3

### General

Types Available:	Relay, SSR drive, solid state and DC linear (Recorder Output only)
------------------	--

### Relay

Contact Type:	Single pole double throw (SPDT).
Rating:	2A resistive at 120/240V AC.
Lifetime:	>500,000 operations at rated voltage/current.
Isolation:	Inherent.

### SSR Drive/TTL

Drive Capability:	SSR > 4.2V DC into 1k $\Omega$ min. ( $\frac{1}{16}$ -DIN) SSR > 4.3V into 250 $\Omega$ min. ( $\frac{1}{4}$ -DIN & $\frac{1}{8}$ -DIN)
Isolation:	Not isolated from input or other SSR drive outputs.

### Solid State

Operating Voltage Range:	20 - 280Vrms (47 - 63Hz)
Current Rating:	0.01 - 1A (full cycle rms on-state @ 25°C); derates linearly above 40°C to 0.5A @ 80°C.
Max. Non-repetitive Surge Current (16.6ms):	25A peak
Min. OFF-State $\frac{dv}{dt}$ @ Rated Voltage:	500V/ $\mu$ s
Max. OFF-State leakage @ Rated Voltage:	1mA rms



Max. ON-State Voltage Drop @ Rated Current:	1.5V peak.
Repetitive Peak OFF-state Voltage, $V_{drm}$ :	600V minimum.

**DC**

Resolution:	Eight bits in 250mS (10 bits in 1 second typical, >10 bits in >1 second typical).
Update Rate:	Every control algorithm execution.
Ranges:	0 - 20mA 4 - 20mA 0 - 10V 0 - 5V

(Changes between V and mA require link jumper movement.)

Load Impedance:	0 - 20mA: 500 $\Omega$ maximum 4 - 20mA: 500 $\Omega$ maximum 0 - 10V: 500 $\Omega$ minimum 0 - 5V: 500 $\Omega$ minimum
Isolation:	Isolated from all other inputs and outputs.
Range Selection Method:	Link jumper or DIP.

**A.6 LOOP CONTROL**

Automatic Tuning Types:	Pre-Tune and Self-Tune.
Proportional Bands:	0 (OFF), 0.5% - 999.9% of input span at 0.1% increments.
Reset (Integral Time Constant):	1s - 99min 59s and OFF
Rate (Derivative Time Constant):	0 (OFF) - 99 min 59 s.
Manual Reset (Bias):	Added each control algorithm execution. Adjustable in the range 0 - 100% of output power (single output) or 100% to +100% of output power (dual output).
Deadband/Overlap:	20% to +20% of Proportional Band 1 + Proportional Band 2.

ON/OFF Differential:	0.1% to 10.0% of input span.
Auto/Manual Control:	User-selectable with bumpless transfer into and out of Manual Control.
Cycle Times:	Selectable from $\frac{1}{2}$ s to 512 secs in binary steps.
Setpoint Range:	Limited by Setpoint Maximum and Setpoint Minimum.
Setpoint Maximum:	Limited by Setpoint and Range Maximum.
Setpoint Minimum:	Limited by Range Minimum and Setpoint.
Setpoint Ramp:	Ramp rate selectable 1 - 9999 LSDs per hour and infinite. Number displayed is decimal-point-aligned with selected range.

## A.7 ALARM CONTROL

Maximum Number of Alarms:	Two soft alarms plus Loop Alarm
Max. No. of Outputs Available:	Up to two outputs can be utilised for alarm purposes.
Combinatorial Alarms:	Logical OR or AND of alarms to an individual hardware output is available.

## A.8 PERFORMANCE

### Reference Conditions

Generally as EN60546-1.

Ambient Temperature:	20°C $\pm$ 2°C
Relative Humidity:	60 - 70%
Supply Voltage:	90 - 264V AC 50Hz $\pm$ 1%
Source Resistance:	<10 $\Omega$ for thermocouple input
Lead Resistance:	<0.1 $\Omega$ /lead balanced (Pt100)

## Performance Under Reference Conditions

Common Mode Rejection:	> 120dB at 50/60Hz giving negligible effect at up to 264V 50/60Hz.
Series Mode Rejection:	> 500% of span (at 50/60Hz) causes negligible effect.

## DC Linear Inputs

Measurement Accuracy:	$\pm 0.25\%$ of span $\pm 1$ LSD.
-----------------------	-----------------------------------

## Thermocouple Inputs

Measurement Accuracy:	$\pm 0.25\%$ of span $\pm 1$ LSD. NOTE: Reduced performance with Type B Thermocouple between 100 - 600°C (212 - 1112°F).
Linearisation Accuracy:	Better than $\pm 0.2^\circ\text{C}$ any point, any $0.1^\circ\text{C}$ range ( $\pm 0.05^\circ\text{C}$ typical). Better than $\pm 0.5^\circ\text{C}$ any point, any $1^\circ\text{C}$ range.
Cold Junction Compensation:	Better than $\pm 0.7^\circ\text{C}$ .

## RTD Inputs

Measurement Accuracy:	$\pm 0.25\%$ of span $\pm 1$ LSD
Linearisation Accuracy:	Better than $\pm 0.2^\circ\text{C}$ any point, any $0.1^\circ\text{C}$ range ( $\pm 0.05^\circ\text{C}$ typical). Better than $\pm 0.5^\circ\text{C}$ any point, any $1^\circ\text{C}$ range.

## DC Outputs - Accuracy

Output 1:	$\pm 0.5\%$ (mA @ 250 $\Omega$ , V @ 2k $\Omega$ ); 2% underdrive (4 - 20mA) and overdrive applies.
Output 2:	$\pm 0.5\%$ (mA @ 250 $\Omega$ , V @ 2k $\Omega$ ); 2% underdrive (4 - 20mA) and overdrive applies.
Output 3 (Recorder Output):	$\pm 0.25\%$ (mA @ 250 $\Omega$ , V @ 2k $\Omega$ ); Degrades linearly to $\pm 0.5\%$ for increasing burden (to specification limits).

## Operating Conditions

Ambient Temperature (Operating):	0°C to 55°C
Ambient Temperature (Storage):	20°C to 80°C
Relative Humidity:	20% - 95% non-condensing
Supply Voltage:	90 - 264V AC 50/60Hz (standard) 20 - 50V AC 50/60Hz or 22 - 65V DC (option)
Source Resistance:	1000Ω maximum (thermocouple)
Lead Resistance:	50Ω per lead maximum balanced (Pt100)

### Performance Under Operating Conditions

Temperature Stability:	0.01% of span/°C change in ambient temperature.
Cold Junction Compensation (thermocouple Only):	Better than $\pm 1^\circ\text{C}$ .
Supply Voltage Influence:	Negligible.
Relative Humidity Influence:	Negligible
Sensor Resistance Influence:	Thermocouple 100Ω: <0.1% of span error Thermocouple 1000Ω: <0.5% of span error RTD Pt100 50Ω/lead: <0.5% of span error

## A.9 ENVIRONMENTAL

Operating Conditions:	See Subsection A.8 - PERFORMANCE.
Approvals:	CE, UL, ULC
EMI Susceptibility:	Certified to EN50082-1:1992 and EN50082-2:1995. NOTE: For line-conducted disturbances induced by RF fields (10V 80% AM 1kHz), the $\frac{1}{16}$ -DIN controller is self-recoverable in the frequency bands 17 - 47MHz and 68 - 80MHz.

EMI Emissions:	Certified to EN50081-1:1992 and EN50081-2:1994.
Safety Considerations:	Complies with EN61010-1:1993.
Supply Voltage:	90 - 264V AC 50/60Hz (standard) 20 - 50V AC 50/60Hz or 22 - 65V DC (option)
Power Consumption:	4 watts approximately.
Front Panel Sealing:	To IP66 (NEMA 4).

## A.10 PHYSICAL

Dimensions	Depth:	110mm ( $\frac{1}{16}$ -DIN controllers)
	Front Panel - Width:	48mm ( $\frac{1}{16}$ -DIN & $\frac{1}{8}$ -DIN controllers) 96mm ( $\frac{1}{4}$ -DIN controllers)
	Height:	48mm ( $\frac{1}{16}$ -DIN controllers) 96mm ( $\frac{1}{4}$ -DIN & $\frac{1}{8}$ -DIN controllers)
Mounting:		Plug-in with panel mounting fixing strap.
Panel cut-out:		45mm x 45mm ( $\frac{1}{16}$ -DIN controllers) 45mm x 92mm ( $\frac{1}{8}$ -DIN controllers) 92mm x 92mm ( $\frac{1}{4}$ -DIN controllers)
Terminals:		Screw type (combination head).
Weight:		0.21kg maximum

## ALPHABETIC INDEX - VOLUME 2

### C

Configuration Mode	
Entry into	3-1
Exit from	3-9
Controller Dimensions	A-12

### D

Dual Setpoint Option PCB	
Removal/replacement	2-3
Dual Setpoint Selection	
TTL-Compatible Input	1-7
Voltage-Free Contacts	1-7

### H

Hardware Definition Code	
Display of	3-2
Input/Output Type	
selection	3-3
Hardware Definition Code	
Adjustment of	3-2

### I

Input Connections	
Dual Setpoint Selection	1-7
Linear	1-7
RTD	1-6
Thermocouple	1-6
Input Type	
Selection of	2-4

### O

Output 1 Type	
Selection of	2-5

Output 2 Type	
Selection of	2-5
Output 2/Output 3 Option PCB	
Removal/replacement	2-3
Output 3 Type	
Selection of	2-5
Output Connections	
DC	1-7
Relay	1-7
SSR Drive	1-7

### P

Panel-Mounting	
Cut-out dimensions	
(multiple installation)	1-1
Cut-out dimensions	
(single installation)	1-1
Maximum panel thickness	1-1

### R

Rear Terminal Connections	1-4
Removing the Controller	
from its Housing	2-1
Replacing the Controller	
in its Housing	2-3
RS485 Communications Option PCB	
Removal/replacement	2-3

**S**

Sensor Break

Effect on outputs  
(DC linear inputs) A-3

Effect on outputs  
(RTD inputs) A-2

Effect on outputs  
(thermocouple inputs) A-2

Serial Communications  
Connections 1-8

Supply Connections  
24V AC/DC Option 1-6

Mains (Line) voltage 1-6